Client Handbook

Client Handbook

29 June 2026

Document number: LU0021

Information in this document is subject to change without prior notice and does not represent a commitment on the part of LuxCSD, société anonyme (referred to hereinafter as “LuxCSD” in this publication).

This document is available in electronic format and may be provided in other formats at the discretion of LuxCSD. LuxCSD grants its clients permission to reproduce, store and print this document to the extent deemed reasonable and necessary for receiving from LuxCSD the services described herein. Any software provided, as set out in the present document, shall be provided under the applicable licence terms.

Unless otherwise stated, all times are given in Central European Time (CET).

All rights reserved.

Foreword

Clients' overall contractual relations with LuxCSD are governed by the General Terms and Conditions of LuxCSD as amended from time to time. Clients agree to abide by these rules when they request the opening of an account with LuxCSD. Clients can obtain copies upon request from their Client Services or Relationship Officer. The General Terms and Conditions can also be found on the LuxCSD website.

This Client Handbook is designed to provide clients of LuxCSD with an overview of LuxCSD, its organisation and its operational procedures. It is a Governing Document as defined in LuxCSD's General Terms and Conditions and is subject to the General Terms and Conditions unless otherwise specified.

Information or notification communicated by LuxCSD to its clients in any form whatsoever is not and shall in no case be considered as investment advice.

This version of the Client Handbook replaces all previous editions of the Client Handbook and shall take effect immediately. The Client Handbook shall remain in effect until clients are otherwise notified.

The Client Handbook is intended to be used in conjunction with other LuxCSD publications (available on the LuxCSD website, www.luxcsd.com) that give further details of how to use LuxCSD's services. Additional documentation is also available on the Clearstream website, www.clearstream.com, for the services outsourced by LuxCSD to Clearstream Banking S.A. (referred to as "Clearstream" in this publication).

LuxCSD reserves the right to update and amend this Handbook from time to time, to reflect the availability of new products and improvements to existing services.

Clients who have specific questions concerning the information contained in this Client Handbook are advised to contact LuxCSD Client Services or their Relationship Officer.

In the event of any conflict between the General Terms and Conditions and the Client Handbook and other Governing Documents, the General Terms and Conditions shall prevail.

The English version of the Client Handbook is legally binding and shall prevail over any translation which may be provided for commercial reasons only.

This page has intentionally been left blank.

Contents

Foreword	i
1. Introduction	
1.1 Corporate structure	1-1
1.2 Compliance	1-2
1.3 Communications with LuxCSD	1-3
1.4 Client Services	1-4
1.5 The service network	1-5
1.6 Services offered by LuxCSD	1-7
1.7 Deadlines	1-10
1.8 Sources of information for clients	1-10
1.9 Enforcement of any pledge granted in favour of LuxCSD	1-13
2. Client accounts	
2.1 Account type and options	2-2
2.2 Account opening and maintenance	2-3
3. Settlement services	
3.1 Settlement types	3-2
3.2 T2S eligible securities instructions	3-3
3.3 Settlement processing of external transactions	3-17
3.4 Settlement finality	3-19
3.5 Reports to clients	3-22
3.6 Settlement reporting under the SDR	3-23
3.7 Interest claims	3-23
3.8 CSDR Settlement Discipline Regime	3-24
4. Cash settlement	
4.1 Cash settlement through T2S	4-1
4.2 Holiday handling	4-2
4.3 Cash settlement outside T2S	4-2
4.4 T2S auto-collateralisation and client-collateralisation	4-3
5. New Issues	
5.1 LuxCSD issued securities	5-2
5.2 LuxCSD principal agents	5-3
5.3 Existing securities not accepted in LuxCSD	5-3
5.4 How to obtain details about securities	5-3

6. Asset servicing

6.1	Exchanges	6-2
6.2	Income services	6-5
6.3	Corporate action services	6-8
6.4	Event notifications and entitlement forecast	6-16
6.5	Payment management of asset servicing proceeds	6-26
6.6	Transaction management	6-29
6.7	Tax services	6-37
6.8	General Meetings services	6-44

7. Communications media

7.1	ClearstreamXact	7-2
7.2	Communications contingency	7-6
7.3	IT releases	7-7

8. Reports and information services

8.1	Choice of reports	8-1
8.2	Reconciliation	8-1
8.3	Connectivity channels	8-4
8.4	Monthly billing reports	8-11
8.5	Client documentation	8-11
8.6	T2S Dedicated Cash Account Statement (MT940)	8-12
8.7	Billing Portal	8-13

1. Introduction

LuxCSD is a *société anonyme* under Luxembourg law (registered with the trade and companies register of Luxembourg under registration number B 154.449), owned by Clearstream International S.A. ("Clearstream International").

LuxCSD has the status of a Securities Settlement System ("SSS").

LuxCSD is supervised by the Commission de Surveillance du Secteur Financier (CSSF) as an authorised central securities depository (CSD) under Article 16 of CSDR.

1.1 Corporate structure

LuxCSD was incorporated on 21 July 2010 with an initial paid in capital of EUR 6.000.000.

The shareholder structure of LuxCSD is illustrated under [About LuxCSD/Organisational Structure/Shareholder Structure](#).

1.2 Compliance

The client shall comply - and ensure compliance by any of the client's underlying clients up to the ultimate legal and beneficial owner - with any national or foreign law, regulation, sanction, order, judgment, injunction, asset freeze, blocking regulation or order or any other act or action of, or by, any national or foreign government, authority, court, (self-) regulatory organisation, government agency or instrumentality of government, including, but not limited to, investment and holding restrictions ("Regulations") applicable to the client, its underlying clients or LuxCSD (including Regulations not applicable to client but applicable to LuxCSD). The client shall not, by action or inaction, cause LuxCSD to violate a Regulation and shall be liable for and hold LuxCSD harmless against any direct or indirect loss, claim, damage, liability or expense, imposed on or incurred by or asserted against LuxCSD in connection with any actual or alleged non-compliance with the aforesaid by the client or any underlying client of such client up to the ultimate legal and beneficial owner.

The client understands and acknowledges that transactions and accounts involving securities issued or held for custody in the European Union ("EU"), EU Member States, the United States of America or other nations are subject to the laws and regulations of those jurisdictions, some of which have extraterritorial application. As a legal person organised under the laws of Luxembourg, an EU Member State, LuxCSD is in all cases subject to applicable Luxembourg and EU laws and regulations. Insofar as LuxCSD conducts its business through US persons, including foreign subsidiaries or affiliates of US persons, the US government may assert jurisdiction over transactions in securities neither issued nor held for custody in the United States. LuxCSD conducts its business to comply with all laws applicable to LuxCSD. Please also refer to the EU sanctions http://eeas.europa.eu/cfsp/sanctions/consolid_en.htm.

Important Note: As part of LuxCSD's internal compliance procedures, all incoming client instructions will be automatically scanned before entering transaction processing. Instructions that are internally flagged as requiring further manual investigation are set to status pending, with such status immediately reported to the client via their chosen media channel(s), until either being manually released for processing or rejected (as these instructions are not presented for settlement, no CSDR "failed settlement penalties" (SEFP) applies, however, late matching penalties (LMFP) may occur). In order to ensure that instructions being investigated do not miss the applicable deadlines, clients are advised to input instructions at least 15 minutes before the associated deadline.

1.3 Communications with LuxCSD

LuxCSD has outsourced its operations to Clearstream and Clearstream Services S.A. (collectively referred to as “Clearstream”). Therefore, day to day communication in relation to the services described in this Client Handbook is handled by Clearstream Banking S.A. on behalf of LuxCSD. This covers all communication media such as phones, Swift messages or other electronic forms of communication.

Clients can send instructions to Clearstream and receive reports, using ClearstreamXact. The ClearstreamXact suite of products, which comprises Xact Web Portal, Xact File Transfer and Xact via Swift¹, and the conditions for their usage, are described in [Chapter 7](#).

LuxCSD has outsourced the settlement of transactions in securities to the T2S platform. This affects transactions against central bank money (CeBM), as well as transactions free of payment. LuxCSD's technical infrastructure supports the use of the various communication channels of Xact for sending instructions to LuxCSD or T2S and receiving reports from LuxCSD or T2S depending on the technical connectivity and the legal status of the technical sender (Indirectly Connected Participant (ICP) or Directly Connected Participant (DCP)).

For LuxCSD clients with DCP status it is possible to send certain instruction types directly to T2S via ISO 20022 messages, to receive messages and reports from T2S and to use the T2S GUI to query information, release or put on hold own instructions. A combination of ICP and DCP connectivity channels is possible even for the same transactions, as an instruction sent to T2S is automatically reflected in LuxCSD and vice versa.

Information about sending instructions to Clearstream is given in [Chapter 4](#) and the reports available through the various media are described in [Chapter 8](#).

1. Swift is a registered trademark of the Society for Worldwide Interbank Financial Telecommunication.

1.4 Client Services

Clients must address their query to Client Services by email or telephone call only. LuxCSD will revert to the client in an appropriate and reasonable period of time. Only the LuxCSD client is entitled to assess which media is the most appropriate.

For urgent matters and to ensure the best possible response time, it is highly recommended that the client contacts Client Services by telephone instead of email. LuxCSD cannot be held responsible in case of delay in responding to an email.

Client Services

LuxCSD Support Team

Phone: +352-243-32820 | Fax: +352-243-632820

Email: cslux@luxcsd.com

Connectivity Support

Phone: +352-243-38110 | Fax: +352-243-638110

Email: connectlux@luxcsd.com

Tax Help Desk

All tax matters - all securities and markets

Phone: +352-243-32835 | Fax: +352-243-632835

Email: tax@luxcsd.com

Note: As is normal practice within financial organisations, LuxCSD has implemented telephone line recording. The main purpose of telephone line recording is to ensure that the interests of LuxCSD and of its clients are protected against misunderstanding or miscommunications under the provisions of the applicable laws.

Recorded telephone conversations may be listened to for the purpose of clarifying the content of business dealings.

- Determine whether business dealings have been conducted;
- Determine the content of business dealings that have been conducted;
- Collate evidence in preparation for arbitration, litigation or private settlement negotiations;
- Determine what information has been provided to third parties including statements made to the press.

1.5 The service network

In order to provide clients with access to a broad range of markets and products, LuxCSD has developed a network of service providers. These, together with LuxCSD itself, comprise the “service network”.

LuxCSD has also established interfaces with other “external” institutions for information or reporting purposes.

Further information on each of the categories illustrated in [Figure 1-1.](#) below.

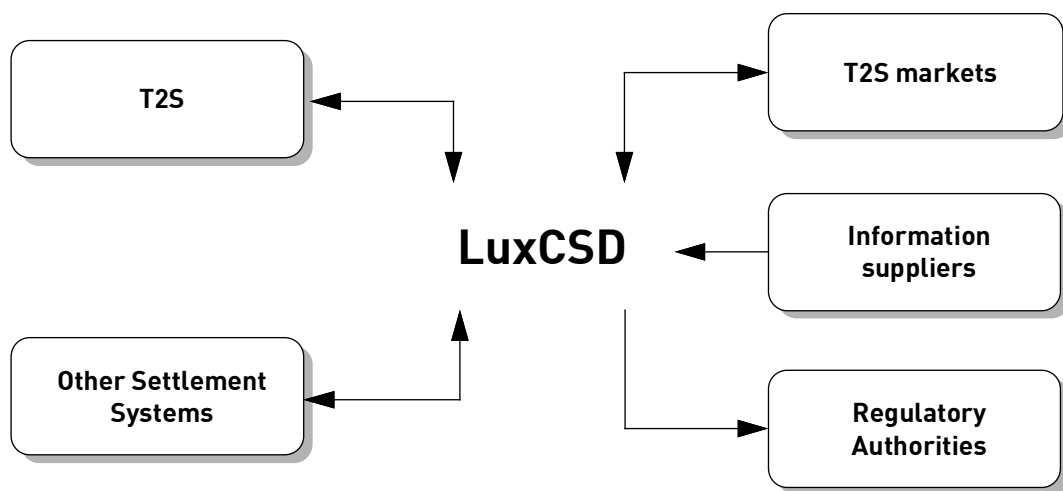

Figure 1-1. The service network

Investor-CSD links

In addition to LuxCSD’s offering for LuxCSD-issued securities on the T2S settlement platform the Investor-CSD links provide LuxCSD clients with a single point of access (in Euro central bank money) to a range of T2S markets.

Furthermore, LuxCSD has

- a CSD link with Iceland, where LuxCSD is a direct participant of Nasdaq CSD Iceland (NCSDI), that offers LuxCSD clients settlement services (FOP only) for equities and debt securities that are eligible in NCSDI; and
- a direct link with Euroclear France for holding French registered securities (Valeurs Essentiellement Nominatives (VEN)).

For further details please refer to the Market Link Guide

Depositories and agents

LuxCSD, as Issuer CSD, provides the safekeeping and the servicing of the eligible securities. The LuxCSD Principal Agent (LPA) is appointed by the issuer to provide the link between the issuer and LuxCSD ensuring timely and accurate processing of the security.

The LPA is responsible for the provision of information related to corporate actions, tax reclaims, redemptions, conversions, etc.; the execution of corporate action instructions provided by the LuxCSD custody system and in the assistance of query resolution. Further details of custody operations are given in [Chapter 6](#).

LuxCSD, as Investor-CSD, has an account with CEU that allows Investor CSD services based on this link. LuxCSD does not use any intermediary, such as an agent, on this link.

LuxCSD's deposits are divided into the following categories:

- **LuxCSD vaults**

Through its vault, LuxCSD holds and services LuxCSD-issued securities.

- **Links with other CSDs**

LuxCSD holds and services securities in the linked domestic markets either via CEU or directly at the Issuer CSD.

1.6 Services offered by LuxCSD

The following diagram shows the most important services which LuxCSD offers.

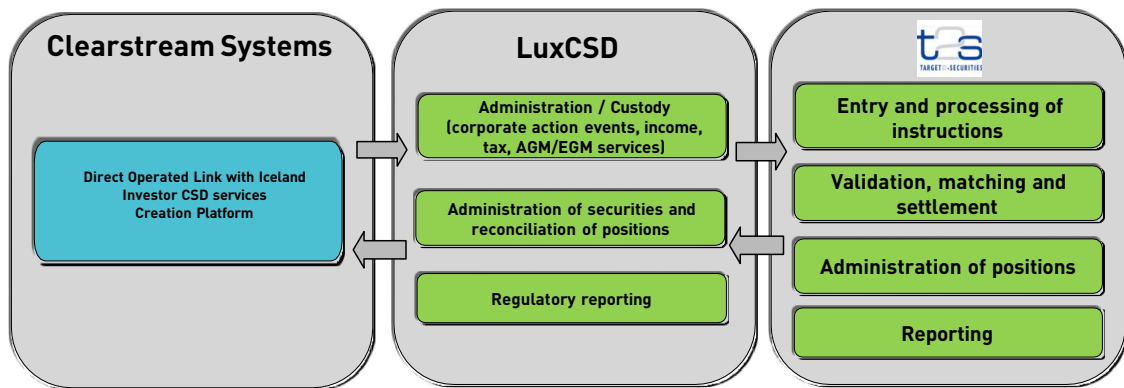

Figure 1-2. LuxCSD's services

T2S

LuxCSD has outsourced the securities settlement in central bank money to the T2S platform provided by the Eurosystem. Cash payments related to against payment (DVP) transactions are settled in central bank money (CeBM) on the T2S platform through the Dedicated Cash Accounts (DCAs) of LuxCSD's clients. Every LuxCSD securities participant account is associated with a T2S DCA. LuxCSD direct participants must fund their T2S DCA from the RTGS DCA in T2 to cover their net cash settlement requirements. In order to participate in DVP settlement, T2S participants need to link their T2S Securities Account (SAC) to at least one DCA via a National Central Bank of the Eurosystem.

Within the securities settlement, T2S takes over the entry and the processing of instructions, the validation, the matching and the settlement of the transmitted instructions, the administration of positions as well as the reporting of transactions and of positions for the securities accounts on the T2S platform (SAC - Security Accounts). Thereby, the settlement, that is, the exchange of the security and cash side, takes place directly on the T2S platform. The cash leg of DVP settlement settles on the associated Dedicated Cash Accounts (DCA).

LuxCSD provides the services of administration of positions in safe custody and the related services as for example corporate actions, dividend payments or services related to general meetings. In addition, a reconciliation of the T2S positions takes place.

Instructions transmitted to T2S are processed in different settlement cycles in T2S. For cash and securities settlement, T2S offers a sequential night-time processing (night-time settlement - NTS) with two cycles and up to two real-time processing cycles (real-time settlement - RTS).

Cash settlement for payments made in EUR take place through the T2S DCA of the participant.

Settlement timing cycle

The settlement timing slots in T2S are according to business days, that is, start of day for a new business day takes place at about 18:45 on the calendar day where the T2S business day ended. Settlement in T2S starts with the night-time settlement (NTS) at about 20:00 and ends with the real-time settlement at about 18:00 (on the next calendar day which is also a T2S business day).

If there is a weekend or a T2S holiday between two T2S business days, the following T2S business day already starts on the last calendar day before the weekend or before the holiday. Settlement within the NTS respectively within the optional RTS also takes place until 03:00 over the change of the calendar day. In this case, the following T2S Maintenance Window lasts until 05:00 on the first calendar day after the weekend or after the T2S holiday.

T2S night-time settlement

Settlement window: NTS

Start: approximately 20:00 (S-1)

End: flexible, approximately 00:00 (S), latest 03:00 (S)

Start FNTC: approximately 20:00 (S-1) / end FTNC: flexible, approximately 22:20 (S-1)

Start LNTC: flexible, approximately 22:20 (S-1) / end LNTC: flexible, approximately 00:00 (S)

The T2S night-time settlement (NTS) is divided into two cycles - the first cycle and the last cycle. The first cycle is subdivided into five sequences and the last cycle into four sequences. Within the different sequences, certain transactions or certain instruction types settle. Detailed timing within NTS depends on processed volumes and is currently kept flexible by the Eurosystem apart from estimated timings for start and end of the two cycles. In general, a sequence ends when T2S has processed all settlement instructions, settlement restrictions and liquidity transfers received before the start of this sequence (for the first sequence before 20:00) which are eligible for settlement in this sequence.

First NTS Cycle:

- Sequence 0: Inbound liquidity management instructions
- Sequence 1: Inbound liquidity management instructions, processing of corporate action on stocks
- Sequence 2: Inbound liquidity management instructions, processing of corporate action on stocks, internal FoP instructions for rebalancing
- Sequence 3: Inbound liquidity management instructions, processing of corporate action on stocks, internal FoP instructions for rebalancing, central bank operations
- Sequence 4: Processing of all instruction types

Last NTS Cycle:

- Sequence 4: Processing of all instruction types
- Sequence X: Processing of all instruction types and partial settlement
- Sequence Y: Outbound liquidity management instructions
- Sequence Z: Inbound, outbound and internal liquidity management instructions

In NTS, instructions free of payment as well as instructions with payments in EUR can settle.

Settlement instructions entered by clients settle only during FNTC, sequence 4 and LTNC, sequence 4 and X. Additionally, partial settlement of eligible instructions takes place in sequence X.

Client instructions for settlement in NTS can be submitted before or after the start of NTS (until the start of sequence X). Matched and unmatched instructions that could not be settled during the NTS will be automatically forwarded to the real-time settlement (RTS).

T2S real-time settlement (optional)

Settlement window: RTS

Start optional RTS: flexible, approximately 00:00 (S)

End: 03:00 (S)

The optional T2S real-time settlement period (RTS) starts directly after the end of NTS. If NTS is not completed by 03:00, this T2S RTS period will be skipped, as in this case the T2S maintenance period from 03:00 to 05:00 will follow right after the end of the NTS.

In the optional RTS during the night, generally the same settlement rules apply as for daytime RTS (see below), that is, all instruction types can be settled in real-time. Partial settlement for applicable instructions is not foreseen during the optional RTS.

Client instructions for settlement in the optional RTS can be submitted during the whole optional RTS (until the end of RTS). Matched and unmatched instructions that could not be settled during the optional RTS or that are sent during the maintenance window will be automatically forwarded to the daytime RTS.

T2S real-time settlement

Settlement window: RTS

Start: 05:00 (S)

During Real Time Settlement, Partial Settlement is executed by T2S at predefined times. Detailed information is available on the Clearstream website under [T2S partial settlement windows](#).

End DvP, RvP, DwP, RwP, PFoD (without BATM¹ flag): 16:00 (S)

End DvP, RvP, DwP, RwP, PFoD (with BATM flag): 17:40 (S)

End FoP: 18:00 (S)

The daytime T2S real-time settlement (RTS) starts directly after the end of the T2S maintenance period at 05:00. During the RTS, all instruction types can settle, whereas specific deadlines depending on the instruction types apply.

Instructions settle in real time - that is, they settle as soon as they enter the T2S system, without any specific sequencing, and priorities are only considered during optimisation runs and during recycling. In addition, five partial settlement windows exist, during which partial settlement for applicable instructions takes place.

Management of partially released instructions

T2S immediately attempts settlement upon the partial release of an instruction. If settlement is feasible, meaning the necessary securities and cash are available, it proceeds without waiting for the next Partial Settlement Window. This ensures that settlement opportunities are not missed between windows, thereby optimising liquidity and operational throughput.

However, if settlement is not possible at that moment, T2S will defer the attempt until the next scheduled Partial Settlement Window.

Client instructions for settlement in the daytime RTS can be submitted before or during the daytime RTS (until the respective deadlines). Matched instructions that could not be settled during the daytime RTS will be automatically forwarded to the night-time settlement of the following business day. Unmatched instructions are forwarded as well, as long as they are pending for less than 20 business days

1. BATM – Bilaterally Agreed Treasury Management

Non-T2S services

LuxCSD offers free of payment external settlement on securities held on selected CSD links outside T2S. For further details please refer to the Market Link Guides. Any custody cash flows on such securities are booked in the ICSD linked account of the client.

1.7 Deadlines

All deadlines quoted in hours and minutes (hh:mm) should be understood to include :00 seconds. For example, 16:00 should be understood to mean 16:00:00.

Compliance with a deadline is assessed against the respective "Clearstream Receive Timestamp". An instruction will be processed automatically provided that the "Clearstream Receive Timestamp" indicates a time before the related deadline. If the "Clearstream Receive Timestamp" of an instruction indicates a time on or after the related deadline, the instruction can be processed on a "best efforts" basis only.

Important Reminder: As part of LuxCSD's internal compliance procedures, all incoming client instructions will be automatically scanned before entering transaction processing. Instructions that are internally flagged as requiring further manual investigation are set to status pending, with such status immediately reported to the client via their chosen media channel(s), until either being manually released for processing or rejected.

1.8 Sources of information for clients

Clients can make specific enquiries and obtain further information about all of the products and services provided by LuxCSD from Client Services or from their Relationship Officer (see [Client Services](#) on page 1-4).

LuxCSD supports the products and services provided to its clients with a range of user documents and other sources of client information, including extensive user guides. Some of these documents, when classified as Governing Documents, are contractually binding on the client as per the General Terms and Conditions.

On the LuxCSD website, www.luxcsd.com, information is provided on all of the products and services provided by LuxCSD in a centralised repository for all current publications, including relevant regulatory related documents. It also provides up-to-date information about activities and events being held by LuxCSD.

The description of operational processes for T2S services in the Client Handbook is based on information obtained from third party sources such as the Eurosystem. LuxCSD cannot be held responsible for the content of such information. For additional T2S information, clients should consult the website of the [European Central Bank](#).

Client publications

LuxCSD maintains a number of publications that are provided in soft-copy form via the LuxCSD website and updated regularly. The following publications support the products and services provided by LuxCSD.

Client Handbook

The Client Handbook (this document) is designed to provide LuxCSD clients with an overview of LuxCSD, its organisation and its operational procedures. The English version of the Client Handbook is

a Governing Document as defined in the General Terms and Conditions and is subject to the General Terms and Conditions unless otherwise specified.

Market Guide

The Market Guide provides information about Investor-CSD markets for LuxCSD clients and describes the market specific processes in the given market which complement the generic processes and services as described in the Client Handbook. Details include, but are not limited to, types of securities traded, types of link, depositories and agents, if applicable, settlement rules and times, and custody services.

Note: LuxCSD may have eligibility restrictions in specific markets.

The Market Guide is organised by market, with the information for each market split across two main sections, as follows:

- Market Profile

Key information, particularly in the areas of settlement and custody, identifying the main institutions and describing local conditions and practices in the market. In addition, relevant website addresses are indicated, where clients can find more detailed information.

- Market Link Guide

Information related to the use of the settlement platforms in the market, such as applicable deadlines, procedures for domestic counterparties, custody services and instruction formats.

The Market Guide is produced in English. An up-to-date version is always available on the LuxCSD website, www.luxcsd.com, under Products & Services / Market Coverage.

The Market Link Guide is a Governing Document as defined in LuxCSD's General Terms and Conditions and is subject to LuxCSD's General Terms and Conditions, unless otherwise specified.

Communications manuals

The following documents provide assistance in the operation of LuxCSD's connectivity services:

- Xact Web Portal User Manual
- Xact File Transfer User Manual;
- Xact via Swift User Guide.

LuxCSD Fee Schedule

Fees and charges levied by LuxCSD for its services are given in the LuxCSD Fee Schedule. This is a Governing Document as defined in the General Terms and Conditions and is subject to the General Terms and Conditions unless otherwise specified. The LuxCSD Fee Schedule is available on the LuxCSD website, www.luxcsd.com.

Announcements

Announcements (including relevant Clearstream announcements, where applicable) give details, in English of changes in custody and clearing and settlement information, changes in taxation, changes to fees and charges, and other information about forthcoming changes in the markets and the products and services provided by LuxCSD. The information given to clients in announcements is integrated, where applicable, into the Client Handbook and other reference documents.

Specific securities data announcements publish regularly issued information about securities, such as newly allocated ISINs and confirmed ISINs.

Announcements containing governing information are individually defined as Governing Documents on a case-by-case basis.

Publication alerts services

The publication alerts services are free of charge email services that inform clients of the publication of new information on the LuxCSD website. These services are available to all clients (or client group members) that are registered as users of the LuxCSD website.

Real-time alerts

Real-time alerts provide immediate notification of the availability on the LuxCSD website of new/amended publications that match the client's preferences as selected when subscribing to the service.

Daily alerts

Daily alerts are emails sent to clients at the end of each day providing a list of all new/amended publications uploaded to the LuxCSD website during that day. The list includes only those publications that match the client's preferences as selected when subscribing to the service.

Announcements via email

This service is designed to enable clients that do not have desktop access to the internet to receive announcements as attachments to emails. The emails are sent overnight.

Weekly Update

The Weekly Update includes a complete list of all new LuxCSD publications, issued during the preceding week.

Statement of Insurance

Clients can request a copy of **the Statement of Insurance**, which summarises the coverage maintained by LuxCSD to protect its clients. This can be obtained upon request from a Client Services Officer or Relationship Officer.

Securities accepted in LuxCSD

A complete list of securities issued by LuxCSD is available as reference data on www.luxcsd.com, and clients that are premium users can obtain details of specific securities by means of the Codelist available under Applications.

The list of LuxCSD securities eligible in T2S is available on our [website](#).

LuxCSD draws the attention of its clients to the fact that for some markets or securities, there are holding restrictions. LuxCSD does not monitor the holding restrictions provided by law or by the issuers. The clients remain at any time solely responsible for the investments they make and consequently for the monitoring of the restrictions of the beneficial owners' compliance thereto.

1.9 Enforcement of any pledge granted in favour of LuxCSD

The right of retention, pledge, set-off and other rights of LuxCSD is laid down by Section 6 of the General Terms and Conditions of LuxCSD. LuxCSD has a general right of retention and set-off on all assets held on the client's account that secure obligations towards LuxCSD by the client for the services rendered by LuxCSD. All assets held by the client within LuxCSD are pledged in favour of LuxCSD to the extent of any present or future obligations that the client has, or may subsequently have towards LuxCSD.

The enforcement of any pledge granted in favour of LuxCSD pursuant to its Governing Documents or other client documentation is carried out in accordance with such documentation and (unless otherwise agreed) by Luxembourg law, it being understood that such enforcement methods may be carried out alternatively or cumulatively.

Unless expressly agreed otherwise, if such enforcement is carried out by:

- private sale, LuxCSD will determine the price by selecting and accepting in good faith offer(s) for any pledged securities determined by LuxCSD to be liquidated. The value of the pledged securities will be the price obtained in such sale.
- appropriation, such appropriation will be made at the value determined by LuxCSD at its absolute discretion and acting in good faith, or by any neutral third party appointed by LuxCSD, or any other pricing information services selected by LuxCSD, each time selected by LuxCSD at its sole discretion for the purposes of making or assisting it in making such determination, considering inter alia any listed price (if any), any published net asset value (if any), the respective market spreads and any liquidation impacts. Such determinations shall be binding on the client absent manifest error.

For the avoidance of doubt, such determination process can be carried out before or after the appropriation. The value of the pledged securities will always be determined as at the date of the appropriation. LuxCSD may elect, in its sole discretion, to appoint another person to which the right to appropriate the pledged securities shall be transferred in lieu of LuxCSD, it being understood that such appointment shall not affect LuxCSD's rights and obligations against the relevant pledgor.

This page has intentionally been left blank.

2. Client accounts

LuxCSD has outsourced the settlement of securities to T2S. LuxCSD clients must keep Dedicated Cash Accounts (DCA) in T2S and RTGS DCA on the T2 platform for the cash leg of settlement transactions and for the receipt of custody proceeds of T2S-eligible securities.

Custody cash flows are carried out through the ICSD-linked cash and securities account managed via CBL's Creation Platform.

At approval¹ of the account opening request, each client account is identified by a unique five-digit account number, and will be allocated a unique LuxCSD account number within the range 48000 to 48999 for settlement in T2S.

Clients can settle transactions and hold balances in any security eligible for admission through a single account with a single account number. A range of options is available for each account opened. Clients are asked to specify which options they require when opening an account.

Clients who wish to modify any of the options for an account should contact Client Services or their Relationship Officer (see [Client Services](#) on page 1-4).

1. LuxCSD clients are central banks, central securities depositories and AML-regulated banks or credit institutions as defined under the Law of 5 April 1993 in Luxembourg, or equivalent foreign AML-regulated banks and credit institutions being submitted to equivalent client identification and anti-money laundering and anti-terrorist financing requirements.

2.1 Account type and options

The following account type is available:

- Standard accounts

All of these accounts can be:

- **Main and additional accounts**

Clients can open a main account and any number of additional accounts. Additional accounts enable clients to distinguish between their own holdings and their underlying clients, in order to cater for specific business areas, or for other purposes.

- **Published or unpublished**

Accounts of clients are generally published: the existence of the account, including the account number and account name, is available through query functions available via Xact Web Portal or via the LuxCSD website.

Upon request and at LuxCSD's discretion, a client can open an unpublished account. Unpublished accounts are not listed in any printed publication. In Xact Web Portal unpublished accounts are visible.

Note: LuxCSD participants are reminded that they shall comply with Article 38(5) and(6) of the CSDR. Accordingly, they shall be ready to offer their underlying clients at least the choice between omnibus client segregation and individual client segregation and inform them of the costs and risks associated with each option (see Article 38(5) of the CSDR). Further, LuxCSD participants shall also publicly disclose the levels of protection and the costs associated with the different levels of segregation that they provide and shall offer those services on reasonable commercial terms (pursuant to the requirements of Article 38(6) of the CSDR). For further details on Article 38 of the CSDR, please refer to the LuxCSD website under [CSDR Article 38 disclosure](#) which includes LuxCSD's information disclosure with regard to Article 38 of CSDR Regulation (EU) No 909/2014 of the European Parliament and of the Council of 23 July 2014 on improving securities settlement in the European Union and on central securities depositories.

2.2 Account opening and maintenance

Opening a main LuxCSD account

Questions relating to the procedures for opening a first main account should be directed to a Relationship Officer (see [Client Services](#) on page 1-4).

The application forms¹ that must be completed and returned by mail to LuxCSD to request the opening of a LuxCSD main account are as follows:

- Client Application Form, duly signed (in original form by mail or qualified electronic form by email);
- Account Application Form, duly signed (in original form by mail or qualified electronic form by email).

Electronic signatures with digital certificates can be used for account opening documents, modification services like novation or merger agreements and KYC forms. Two signature types are available and accepted - simple electronic signature (SES) or qualified electronic signature (QES) based on the document type and level of security needed. QES provides the strongest level of signer assurance as it is the only signature type in the EU that is recognised as the equivalent to a handwritten signature.

For clients based in Continental Europe and the Nordics, LuxCSD has selected DocuSign as a digital platform for electronic documents and signature acceptance based on the legislative framework [established by the European commission](#).

Application Forms must be provided with QES signature.

Separate forms are also completed to subscribe to a communications medium. The application forms for Xact Web Portal, Xact File Transfer and Xact via Swift are available on request and from the [LuxCSD website](#).

Applicants must also submit²:

1. Up-to-date, official and complete list of authorised signatures. Please provide original documents.
2. Certified true copy of the articles of association and, if the articles are not available in English, French or German, a certified English translation.
3. Certified true copy of the Banking or Business licence (to operate as a financial institution under Luxembourg law or any equivalent category under the client's national law) and, if the licence is not available in English, French or German, a certified English translation.
4. Extract of the company's register (official or certified copy) including certificate of residency and, if the document is not available in English, French or German, a certified English translation.
5. Copy of the company's most recent audited Annual Report. In the case of a subsidiary, please also provide the latest audited Annual Report of the parent company.
6. U.S. Patriot Act certification (if applicable).
7. The following additional documents required are required in case an official signatory list has not been transmitted, or in case of a specific delegation of the signature authorities to individual or legal persons by board members:
 - Certified true copy of minutes of appointment of directory (board resolutions);
 - Certified signed accompanying letter of directors appointing authorised signatories, whereby directors' signatures have been certified correct by notary or equivalent (if the accompanying letter is not certified in this way, please provide certified true copies of the passports of the directors appointing signatories);
 - List of authorised signatures signed by appointing directors.

1. These application forms are available at www.luxcsd.com under Key Documents.

2. If any amendments are made to submitted documentation, the updated documents must be sent to LuxCSD as soon as they become available.

8. Detailed report written on your company by a recognised rating agency (if available).
9. Due Diligence and Sanctions Questionnaire.
10. Wolfsberg Questionnaire and Sanctions Certificate (if applicable).
11. CRS - Entity tax residency self-certification form.
12. FATCA self-certification Form.

Note: Certified copies of company documentation (articles, licence, minutes) are to be made by a competent authority under Luxembourg regulation or under the national regulation of the applicant's jurisdiction (such as notary, embassy, police officer). Proof of the competency of the authority to certify copies must be attached for clients not under Luxembourg regulation.

Requests to open a LuxCSD account should be addressed to the attention of the Client Relations Department.

When a request by a new client to open an account is approved, the new client is notified by Swift or letter. The client then receives by standard mail the necessary information for using a LuxCSD account. This includes the account number, passwords (where applicable) and relevant LuxCSD publications. LuxCSD reserves the right not to accept an application for a LuxCSD account from a new client, and is not obliged to disclose its reasons for so doing.

Opening additional LuxCSD accounts

Additional accounts can be opened without repeating the full initial application procedure. In order to request the opening of an additional account, clients must apply, either, via Xact Web Portal, by sending an authenticated Swift message, or a duly completed Account Application Form or a letter bearing authorised signatures to LuxCSD, for the attention of Banking Operations (Account Administration Luxembourg). The request must include details of:

- The main account number;
- The name for the additional account (maximum 35 characters), which must begin with the same name as that of the main account;
- Whether the account is to be published or unpublished;
- Whether the account holding is proprietary or third-party assets;
- For third-party asset accounts, whether the account is to be omnibus or segregated;
- For segregated accounts, indicate the identity of the underlying client (to be recorded by LuxCSD in the business partner register):
 - Legal name;
 - Address containing city, post code and country.
- The ICSD linked account(s) for income proceeds for LuxCSD issued securities eligible in T2S. These will be the same for the main account and any other accounts opened by the same company;
- Whether or not the communication links will be the same as for the main account;
- Whether or not securities and/or custody reporting will be the same as for the main account;
- Whether or not the account is to be added to a granted Power of Attorney, indicating the date of the relevant Power of Attorney and the Attorney's name;
- The name and telephone number of a contact person;
- Any special requirements (such as recycling of instructions when the security code is not yet open, selective acceptance of delivery instructions without matching instructions, etc.);

The following must be provided:

- Reports setup (ISINs);

- BIC11 settlement party identifier;
- Related Dedicated Cash Accounts (DCA);
- (I)CSD linked accounts, that are the same for the main account and any other accounts opened by the same company.

Unless the client instructs LuxCSD otherwise, LuxCSD will use, for all additional accounts opened in the client's name, the same designation for the account holder, and the same information on authorised signatures as that provided by the client for the first account opened.

Liability for the fulfilment of all obligations related to such additional accounts remains solely with the client.

Account maintenance and other fees

All fees are detailed in the [LuxCSD Fee Schedule](#) which is published regularly.

Updates to supporting documents

Clients are required to provide LuxCSD, on an ongoing basis and at the earliest opportunity, with any amendments to the documentation listed in "[Opening a main LuxCSD account](#)" on page 2-3. The updated documents must be sent to LuxCSD, for the attention of Banking Operations (Account Administration Luxembourg), as soon as they become available.

Closing a LuxCSD account

Without prejudice of articles 53 and 54 of the General Terms and Conditions, LuxCSD or the client can close an account upon one month's written notice.

To request the closing of an account, the account owner must apply, either, via Xact Web Portal, by sending an authenticated Swift message, or a letter to LuxCSD, bearing authorised signatures to the attention of Banking Operations (Account Administration Luxembourg). The Swift message, Xact Web Portal request or letter must also include instructions for the clearing of any balances in the account.

The client shall support all due fees, commissions and other charges still to be calculated when closure request reaches LuxCSD.

The client shall be released from obligations towards LuxCSD when LuxCSD confirms to the client that the account is closed.

This page has intentionally been left blank.

3. Settlement services

LuxCSD is a Central Securities Depository (CSD) providing, as part of its core services offering, the issuance, safekeeping and settlement of securities. LuxCSD will offer services as issuer CSD and as an investor CSD based on a link with Clearstream Europe AG in T2S, offering a wide range of instrument types.

The settlement services related to EUR markets are carried out by means of computer-based book-entry system operated by LuxCSD and the Eurosystem ([Section 3.1](#)). They are sub-divided into intra-CSD settlement (both counterparties are LuxCSD account holders) and cross-CSD settlement (one of the counterparties is an account holder at another T2S CSD).

External FOP settlement outside T2S is available on selected CSD links.

Short selling of income or corporate action proceeds

Short selling of income or corporate action proceeds (that is, selling securities with entitlement to the income or corporate action proceeds covered by a receipt of the same securities without entitlement to the income or corporate action proceeds) is not authorized in LuxCSD.

Accordingly, LuxCSD reserves its discretionary right to debit the account (ICSD linked account, or the DCA, as the case may be) of the client instructing such short selling for an amount equivalent to the gross income or gross corporate action proceeds. In addition, the client instructing such short selling shall indemnify LuxCSD against all direct or indirect liabilities, damages, expenses, losses or any claims that LuxCSD might incur if other LuxCSD client(s) or any other third party have either been deprived due to the short selling from all or part of their entitlement to tax reclaims (if any) linked to the income or corporate action proceeds received by such LuxCSD client(s) in respect of the securities of the same description as the ones in which the short selling transaction occurred, or have suffered any other loss, damages, expenses, costs or claims due to the short selling.

More generally, the client instructing the short selling of income or corporate action proceeds, that is, the seller, shall be responsible and liable for all the consequences of the short selling on the tax treatment of the tax reclaims under the relevant tax regime.

Please refer to [Chapter 6](#).

3.1 Settlement types

LuxCSD provides settlement services for both free of payment (FOP = transfer of securities between two counterparties) and against payment transactions (DVP = simultaneous exchange of cash versus securities between two counterparties). The processing of these settlement types is specific, according to where the client's counterparty wants to receive settlement.

T2S transactions

LuxCSD offers a securities settlement service in T2S with Euro Central Bank Money covering all Euro denominated securities issued through LuxCSD.

In addition, this service covers securities made T2S-eligible by CEU as Issuer-CSD through cross-CSD settlement in T2S. LuxCSD offers investor CSD services for a number of countries through CEU as investor CSD. For the specific details of the link to CEU and the markets covered, please refer to the Market Link Guide.

For the purpose of settlement in French registered securities (Valeurs Essentiellement Nominatives (VEN)), LuxCSD maintains a direct link with Euroclear France.

Transactions outside T2S

External settlement

Trades with counterparties in domestic markets outside T2S, supported using selected direct CSD links, are referred to as "external settlement". These vary in their settlement timing according to the market and the instrument. For further details please refer to the Market Link Guide.

3.2 T2S eligible securities instructions

Overview

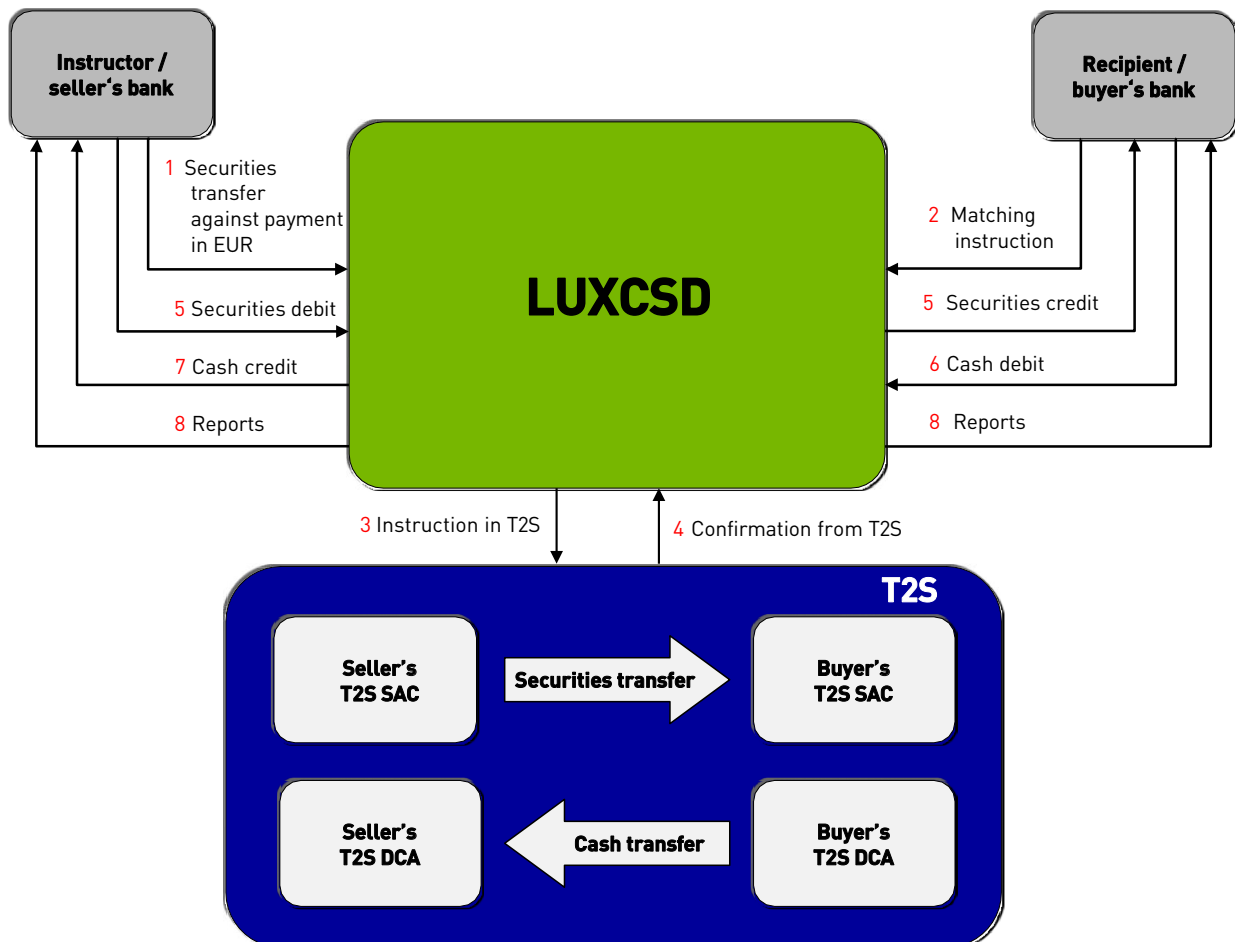

Settlement instruction details

Your settlement instruction can contain the following fields:

- Linkages;
- Partial release;
- Partial settlement;
- BATM flag¹;
- Opt-Out flag;
- Ex-cum flag ;
- ISO transaction codes;
- Market claims and transformation.

The above parameters can be entered in Xact Web Portal screens as well as in the ISO 15022 message formats.

Note: LuxCSD can only accept instructions with up to 6 decimal places.

1. A transaction is considered BATM (Bilaterally Agreed Treasury Management) only if the securities transaction condition (STCO) code COEX/ADEA (Accept After Regular Settlement Deadline) is specified in both legs of the transaction.

Even if not a matching field, as per the Settlement Discipline Regime, LuxCSD client should use a field indicating the transaction type in their settlement instructions based on the following taxonomy:

- Purchase or sale of securities;
- Collateral management operations;
- Securities lending/borrowing operations;
- Repurchase transactions;
- Other ISO codes.

Please refer to the Xact via Swift user guide for more information.

T2S instruction types

The following instruction types will be offered for settlement in T2S against LuxCSD counterparties (intra-CSD settlement) and against counterparties holding accounts at other T2S CSDs (cross-CSD settlement):

Instruction type ^a	ISO 15022
Receive free	MT540
Receive against payment	MT541
Deliver free	MT542
Deliver against payment	MT543

- a. With reference to the T2S User Details Functional Specifications (UDFS 4.2, 30.08.2019), the following settlement instruction types are classified in T2S (Chapter 1.2.5 Instruction Types):
 FoP: Free of payment;
 DVP/RVP: Delivery or receipt versus payment, (an exchange of securities against cash);
 DWP/RWP: Delivery or receipts with payment (delivery of cash and securities from one party to another);
 PFoD: Payment free of delivery (exchange of cash without the delivery of securities).
 Please refer to the following link for the complete document UDFS 4.2: <https://www.ecb.europa.eu/>
 Settlement instruction types DWP/RWP and PFoD are used by LuxCSD in the context of transaction management and corporate actions payments processing and are referred to in the LuxCSD Client Handbook where relevant.

Delivery free of payment and receive free of payment

Delivery free of payment and receive free of payment instructions are the exchange of securities without exchange of cash.

Delivery free of payment and receive free of payment instructions can settle on all T2S settlement days independent of the T2 RTGS holiday calendar. 1 January, 25-26 December and weekends are excluded from the settlement.

This means that free of payment instructions can also settle on all T2 RTGS holidays, provided that T2S is open.

Delivery against payment and receive against payment

Delivery against payment and receive against payment are the transfer of securities from the deliverer to the recipient with the simultaneous exchange of cash from the recipient of the securities to the deliverer. The exchange of cash in T2S is only possible in EUR; LuxCSD does not offer to settle against payment transactions in other currencies in- or outside T2S. The cash leg of instructions against EUR settles on the DCAs in T2S.

While EUR and DKK are eligible currencies for T2S settlement against payment in CeBM (Central Bank Money), note that LuxCSD currently only offers T2S settlement against EUR; the T2 RTGS holidays apply.

Instruction deadlines in T2S

Within the real-time settlement, the following deadlines apply in T2S for same-day settlement:

- 16:00: Transactions against payment;
- 18:00: Free of payment transactions.

Important Reminder: As part of LuxCSD's internal compliance procedures, all incoming client instructions will be automatically scanned before entering transaction processing. Instructions that are internally flagged as requiring further manual investigation are set to status pending, with such status immediately reported to the client via their chosen media channel(s), until either being manually released for processing or rejected. In order to ensure that instructions being investigated do not miss the applicable deadlines, clients are advised to input instructions at least 15 minutes before the associated deadline.

Late instructions

LuxCSD will not consider, in a given settlement processing, any instruction received after the specified deadline for that processing.

Cancellation of instructions

Bilateral cancellation

Matched instructions require the cancellation of both instruction legs to execute the cancellation. If a cancellation is requested for one instruction leg, the transaction can still be eligible for settlement.

The Bilateral cancellation model is applicable to all matched and already matched intra-CSD and cross-CSD instructions in T2S.

Unilateral cancellation for unmatched instruction

Unilateral cancellation applies to all unmatched instructions. Clients can cancel their unmatched instructions and T2S automatically cancels unmatched instructions after the end of the T2S Automated Cancellation Period, that is, after 20 working days from the intended settlement date or the last status update of an instruction.

Cancellation instructions

A cancellation can be requested via the existing Swift MT540-MT543 instructions.

1. When one counterparty requests the cancellation it is forwarded to T2S for processing;
2. In T2S, the cancellation request is processed immediately within the daytime window. Cancellations sent during the night-time sequences are only processed after the end of the sequence;
3. If the cancellation is accepted by T2S, the counterparty receives a status update for their respective instruction via MT548.
4. Only when T2S receives the counterparty's cancellation request then both instructions are finally cancelled. Both counterparties receive the confirmation of the cancellation via MT548.

Cancellation requests can either be rejected (if not correct) or denied (the respective instruction is either cancelled or settled), if:

- The instruction is already "Settled" or "Cancelled";
- The cancellation request is a duplicate.

Instruction recycling in T2S

T2S has a recycling period for both unmatched (20 business days) and matched instructions (60 business days). At the end of the period, any pending instructions will be automatically cancelled by T2S.

The specific rules are defined below:

Unmatched instructions

- Unmatched instructions are recycled for 20 business days (countdown from the ISD or the date of instruction last status change);
- Unmatched cancellations are recycled for 20 business days (countdown from the receipt date).

Matched instructions

- If there is no status change, an instruction which was matched in T2S before its ISD will be cancelled by T2S if not settled by end-of-day (EOD) on ISD+60 business days.
- If there is no status change, an instruction which was matched in T2S on its ISD will be cancelled by T2S if not settled by EOD on ISD+60 business days.
- If there is no status change, an instruction which was matched in T2S on its ISD+50 business days will be cancelled by T2S if not settled by EOD 60 business days after matching (for instance, ISD+110 business days).
- If there is a status change after matching, the 60-business day counter mentioned above is reset to zero (another 60 business days must pass, without status change, for the matched instruction to be automatically cancelled by T2S). Any partial settlement (for instance, first or subsequent partial settlement) also resets the counter to zero.

Modification of instructions

Certain attributes can be modified without cancelling and re-instructing an instruction.

The modification of instructions is allowed for:

- Priority level;
- Hold/Release (Party Hold only);
- Partial release indicator;
- Partial settlement indicator;
- Linkage with processing position code (not for linking via Pool).

Clients can modify only one process indicator per modification request. Every modification needs to be requested separately. If the client wants to modify any field other than the above modifiable fields in an instruction, the instruction must be cancelled and re-instructed.

The modification of the Hold/Release indicator within an instruction is an existing LuxCSD service and will remain unchanged that is, MT540-MT543 messages can still be used for this purpose.

The Xact Web Portal functionality allows clients to modify the partial settlement indicator, the partial release indicator, the priority levels and linkage parameters.

Modification is possible during the instruction lifecycle that is, as long as the settlement status is still "Pending" or "Pending, partially settled".

The following process applies for instructions marked for modification:

LuxCSD sends a cancellation request to T2S:

- If the marked instruction is unmatched in T2S, the cancellation is executed immediately;
- If the marked instruction is matched in T2S, the cancellation is only executed after the counterparty has sent the cancellation request (bilateral cancellation process) for their

instruction as well. In this case, a copy of the instruction is displayed in the entry status screens after the cancellation is executed;

- When a cancellation is executed in T2S, a copy of the instruction is displayed in the amendment screen where the client can modify the instruction details.

In A2A channels a similar feature does not exist, the modification of other instruction details is only possible by cancelling and re-instructing the instruction.

T2S Party identification

A party identification in T2S will always be based on the BIC11 of the T2S participant plus the BIC11 of the respective CSD/National Central Bank (NCB) entity (that is, the CSD or NCB where the party was opened in T2S).

T2S Securities Settlement accounts

On T2S each CSD participant is identified by the BIC of its CSD plus its own BIC. A financial institution having a relationship with different CSDs and NCBs will be defined several times as a party. For example, a bank having a relationship with two different CSDs and one NCB will be recognised as three parties in T2S (that is, at least as a participant for each CSD and as a payment bank for the NCB). Participants can open one or several accounts under the same Party BIC.

T2S cash accounts for settlement

Cash settlement in T2S eligible currencies (at the moment only Euro) will be processed via Dedicated Cash Accounts (DCA) in T2S. The funding of these DCAs will be done from the RTGS DCA in T2. In order to participate in delivery against payment settlement, T2S participants need to link their T2S Securities Account (SAC) to at least one DCA via a NCB. The DCA number will be provided by the NCB.

Matching in T2S

All instructions that settle in T2S are also matched by T2S (LuxCSD does not accept already matched instructions for settlement in T2S). The T2S matching rules apply equally to intra-CSD and cross-CSD instructions.

Matching in T2S takes place on party level; at the related BIC11 level.

Note: T2S distinguishes between upper and lower case letters. Therefore, clients should consider proper spelling with respect to case sensitivity if upper and lower case letters are used. LuxCSD suggests to only use upper case in order to avoid rejections in case of wrong spelling with respect to case sensitivity.

T2S provides real-time matching facilities throughout the operating day (except for maintenance windows). Following a matching attempt, the instruction is given the status "matched" or "unmatched". T2S provides information to the instructing parties on the result of the matching process.

Matching criteria

The T2S matching criteria are categorised into:

- Mandatory matching fields;
- Additional matching fields;
- Optional matching fields.

Mandatory matching fields

Mandatory matching fields must be filled in both the delivery and the receipt instruction and the values need to correspond in order to match. The values either need to be identical or opposite in order to match.

Matching rules

The following criteria are mandatory for free of and against payment instructions in T2S:

- Payment type (APMT/FREE);
- Securities movement type (DELI/RECI and the values match opposite);
- ISIN code;
- Trade date;
- Settlement quantity;
- Intended settlement date;
- Delivering party BIC;
- Receiving party BIC;
- CSD of delivering party (place of settlement or place of safekeeping); and
- CSD of receiving party (place of settlement or place of safekeeping).

For against payment transactions, the following criteria are also mandatory:

- Currency; and
- Settlement amount.

Matching tolerance

If all fields on both instructions match with exception of the settlement amount, T2S checks if the difference between both settlement amounts is within the tolerance amount defined in T2S. The T2S tolerance is not fixed but depends on the cash amount as follows:

- EUR 2 for settlement amount less or equal EUR 100.000
- EUR 25 for settlement amount strictly above EUR 100.000

If there is more than one potentially matching settlement instruction in the system, T2S matches against the one with the smallest difference in the settlement amount. If there is more than one potentially matching settlement instruction with an identical settlement amount, T2S matches against the one with the closest entry time in T2S.

If instructions with different settlement amounts match, the amount of the delivering party settles.

Additional matching fields

Additional matching fields are not mandatory fields but their values have to match as soon as one of the counterparties fills the field in their instruction. Consequently, the other counterparty needs to fill this field with the same value in order to achieve matching. A filled additional matching field cannot match with a blank field.

The additional matching fields for against and free of payment instructions are:

- Opt-out ISO transaction condition indicator;
- Ex Coupon / Cum Coupon indicator.

Optional matching fields

For optional matching fields, a filled field may match with a field with no value (unlike additional matching fields), but when both parties provide a value, the values have to match.

The optional matching fields for against and free of payment instructions are:

- Common trade reference;
- Client of receiving CSD participant;
- T2S SAC of receiving party.

With T2S, counterparties can try to influence the matching of specific instructions by filling the above fields. However, there is still a risk of cross-matching with other instructions as these fields are optional matching criteria and, therefore, may also match with a blank field. The cross-matching risk

can be reduced if both counterparties fill the optional matching fields with an agreed value, for instance, the Common trade reference can be used for foreign currency instructions.

Transaction Linking Service under T2S

T2S provides the functionality to link settlement instructions to each other, so that they are settled together or in a specific sequence. Linked instructions are subject to special rules during the business validation, with respect to eligibility or settlement processes.

The linking of instructions is possible in two ways:

- Linking of several instructions via a common pool reference (“Pool”);
- Linking of two or more settlement instructions via a processing position code (“Linkage”).

Clients can only link their own instructions to instructions that are

- Instructed by the same T2S party (that is, own instructions);
- Instructed by another T2S party for which the client operates the account via PoA (Power of Attorney).

Linking via pool reference

Clients can link two or more settlement instructions via a pool reference which is a collective reference to identify a set of settlement instructions that are to be settled together as all or none.

- Instructions can be pooled in any combination of deliveries and receipts as required by the client:
 - Deliveries together with receipts;
 - Deliveries only;
 - Receipts only.
- All instruction types described above can be pooled;
- Instructions can be pooled across ISINs.

A pool is created by entering a common pool reference within each of the instructions which are to be included in the pool.

A settlement instruction is included in the pool if it contains the following details:

Pool reference

The pool reference is a collective reference to identify a set of settlement instructions. Clients can define the pool reference themselves within the following restrictions:

- Up to 16 alphanumeric digits (Swift compatible-Character Set X);
- Up to 999 settlement instructions can be linked within one pool reference.

Pool counter

The pool counter represents the total number of instructions within a pool.

The following rules apply:

- The number of linked instructions within the pool must not exceed the pool counter;
- Any instruction added to a pool is rejected if this instruction would increase the total number of pooled instructions to a figure exceeding the pool counter;
- If the total number of instructions within the pool is lower than the pool counter, none of the instructions within the pool will settle;
- The pool counter must be identical in each instruction included in the pool.

Pool owner BIC

The pool owner BIC is the BIC of the client creating the pool. When a client creates a pool their own BIC is to be filled.

Sequential number

The sequential number is the number assigned to a settlement instruction within the pooled set of instructions. Please note that the sequential number must be included in the instruction but is not validated by LuxCSD and T2S.

Amendment of a pool

All pool parameters can only be amended if all instructions within the pool are cancelled and re-instructed with a different pool reference.

- Pooled instructions cannot be unlinked via modification. This also applies if instructions are to be added to a pool or to be deleted out of a pool;
- The pool becomes invalid and will not settle if one instruction is cancelled.

Linkage of individual instructions

When submitting settlement instructions to T2S, it is possible to link them to other settlement instructions in T2S. Instructions can be linked with the following types:

- WITH - settle together with the linked instruction;
- BEFO - settle before or at least at the same time as the linked instruction;
- AFTE - settle after or at least at the same time as the linked instruction;
- INFO - association between two or more instructions for information purposes.

More than two instructions can be linked via pool reference. Linkages of type WITH/BEFO/AFTE will prevent partial settlement.

Based on the T2S concept for "instruction linking," LuxCSD will implement WITH, BEFO, AFTE and INFO services. Links created by LuxCSD cannot be modified by clients.

Settlement instructions and settlement restrictions can be linked together either via a link specified by:

- T2S Actor or via a link generated automatically by T2S.
- A T2S Actor links Settlement Instruction(s) and/or Settlement Restriction(s) together by making the use of a processing position code corresponding to:
 - [WITH] All-or-none, which means that a settlement instruction, or settlement restriction is to be settled at the same time as the linked settlement instruction or settlement restriction, the link reference and link owner are mandatory fields;
 - [BEFO] Before, which means that a settlement instruction or settlement restriction is to be settled before or at least at the same time as the linked settlement instruction or settlement restriction;
 - [AFTE] After, which means that a settlement instruction or settlement restriction is to be settled after or at least at the same time as the linked settlement instruction or settlement restriction;
 - [INFO] Information, which means an association between two or more instructions for information purposes.

With the use of a processing position code, a T2S Actor can link together:

- Two settlement instructions;
- Two settlement restrictions;
- One settlement instruction with one settlement restriction;
- One settlement instruction or settlement restriction can be executed before, after or at the same time as an existing pool, by linking the instruction to any instruction that belongs to that pool,

through a processing position code, WITH, AFTE, BEFO or INFO, and the reference of the linked instruction. In this case, no pool reference is needed.

- Settlement instruction(s) and/or settlement restriction(s) can be linked whatever the type (delivery/receipt), the ISIN code or the Intended Settlement Date, provided that the links do not contradict each other.

The settlement day

LuxCSD will follow the T2S settlement day as described below.

Any settlement activity in T2S takes place within five different T2S periods. Two of these T2S periods - end of day processing from 18:00 CET to 18:45 CET and start of day preparation from 18:45 CET to 20:00 CET on SD-1 - are reserved for automated technical processes preparing for or following up on the settlement day.

Securities settlement takes place in three T2S periods:

- Night-time settlement

Night-time settlement (NTS) runs from 20:00 CET on SD-1 until at the latest 03:00 CET on SD. NTS is divided into two cycles - the first cycle and the last cycle. The first cycle is subdivided into five sequences and the last cycle into four sequences. Within the different sequences certain transactions or certain instruction types settle.

At the end of the last night-time settlement cycle (as of sequence X), T2S submits, for partial settlement, all eligible transactions that failed to be settled in an earlier attempt during the night.

- Real-time settlement during the night

The overnight T2S real-time settlement period (RTS) starts directly after the end of NTS. If NTS is not completed by 03:00 CET, this T2S RTS period will be skipped as, in this case, the T2S maintenance period will follow right after the end of the NTS.

- Real-time settlement during the day

The daytime T2S real-time settlement period opens directly after the end of the T2S maintenance period at 05:00 CET and runs throughout the business day until 18:00 CET.

Between 03:00 CET and 05:00 CET, T2S performs maintenance during which instructions can be submitted but will only be settled in the next T2S settlement period.

Partial settlement takes place at 08:00 CET, 10:00 CET, 12:00 CET, 14:00 CET and 15:30 CET.

T2S Periods	Timing	Specifics
Start of Day (SoD)	18:45 – 20:00	Technical T2S period: Change of settlement day Prepare night-time settlement (NTS)
Night-time Settlement (NTS)	20:00 – 03:00	First T2S settlement period: NTS is composed of two cycles <ul style="list-style-type: none"> • First cycle consisting of five sequences • Last cycle consisting of four sequences
Real-time Settlement (RTS)	This T2S period is dropped if NTS is not completed by 03:00	Second T2S settlement period: Real-time processing of instructions
Maintenance Window	03:00 – 05:00	No settlement or instruction management activity: Instructions can be submitted but will be queued until the next T2S period starts
Real-time Settlement (RTS)	05:00 – 18:00	Third T2S settlement period: Real-time processing of instructions
End of Day (EoD)	18:00 – 18:45	Technical T2S period: Follow-up processes like for example, unmatched instructions pending for more than 20 days are cancelled

Hold/Release for securities settlement instructions in T2S

LuxCSD uses the T2S hold/release procedures. This functionality enables clients to hold or release settlement instructions at any time during the lifecycle until they are settled or cancelled. On the intended settlement date, T2S informs the counterparty that its instruction cannot be settled due to the settlement instruction being on hold (without detailing the type of hold). Instructions "on party hold" can be matched by T2S, and a settlement instruction can be sent initially "on hold" or already "released." Also, a client can change the hold status at a later stage before settlement or cancellation is executed. For "party hold," the hold indicator can be changed in both directions: hold to release or release to hold.

Within the settlement processing, LuxCSD supports all four T2S hold indicators. However, based on the T2S definition, clients can only use the indicator "party hold" (PTYH).

T2S offers the following types of Hold and Release:

- Party Hold (PTYH): A T2S instruction is in status "party hold" further to a client request when the instruction is sent or later if the instruction is still pending. This is the functionality described in this paragraph.
- CSD Hold (CSDH): A CSD can also request to put an instruction on hold.
- CSD Validation Hold (CVAL): This status is given by T2S in case of transaction blocking.
- CoSD hold (CDEL): This status is given by T2S in case of conditional settlement.

Clients must be set up in T2S to use the Hold and Release functionality.

Hold process

A hold instruction is denied by T2S if the instruction is:

- Cancelled;
- Settled;
- Identified as a CoSD;
- Already put on hold by the relevant T2S Actor (T2S Party or CSD).

If the instruction is successfully put on hold, the T2S Actor is informed through a message communicating the execution of the Hold Instruction and a Status Advice message.

Only on the Intended Settlement Date and if the instruction is still on hold, the counterparty is informed (at the start of day) about the hold status of the instruction.

Release process

A release instruction is denied by T2S if the instruction is:

- Cancelled;
- Settled;
- Already released by the relevant T2S Actor or by the relevant CSD in the case of the CSD Validation Hold or by the Administering Parties in case of CoSD Hold.

If the instruction is successfully released, the T2S Actor is informed through a message communicating the execution of the Release Instruction and a Status Advice message informing if other hold remains.

Only if the ISD has been reached and if no other hold remains, the counterparty is informed about the release of the instruction.

Prioritisation

With the implementation of T2S, only four priority levels are available and can be assigned to delivery and receipt instructions, of which only two of them can be assigned by the client. The others are reserved for the exclusive use of CSDs, NCBs (National Central Banks), CCPs or trading platforms.

LuxCSD will align with T2S prioritisation logic. Presently, T2S supports four different levels of priority for settlement instructions:

1. Reserved priority (can be used only by CSDs and NCBs);
2. Top priority (can be used by SEs, MTFs and CCPs);
3. High priority (available at all times for T2S Actors);
4. Normal priority (available at all times for T2S Actors).

LuxCSD clients will be able to define two levels of priority only:

- High priority; and
- Normal priority, where normal is the default value.

Instruction specifics

Clients can set the priority levels 3 (High) and 4 (Normal) within the instruction. The priority is an optional attribute. If the priority is not set T2S will assign the standard priority level 4 (Normal) to the instruction. For instructions entered via Xact Web Portal, the priority can be set in the existing field.

Both counterparties can define priorities and T2S would determine which priority to apply if those are differently instructed by both counterparties.

If the matching delivery and receipt instructions hold two different priority levels T2S applies to the highest of the two.

Priorities are considered within the T2S settlement process for instructions as follows:

1. Higher to lower priority level;
2. Oldest to most recent settlement date.

During the night-time settlement period, the priorities of all settlement instructions are taken into account before any settlement attempt;

During the real-time settlement period (daytime), the priorities of settlement instructions are taken into account during the recycling and optimisation process, however, not at the first settlement attempt (first come first served).

Partial release in T2S

The partial release functionality enables the partial release of the quantity specified in a pending securities settlement transaction instruction and is offered for delivery instructions.

The request can be initiated with the "Hold / Release functionality" by specifying the quantity to be released.

Clients can select which position they want to flag for release. T2S will execute the request within all defined Partial Settlement windows during the day and night-time processing. If a partial release request is accepted by T2S for settlement during a current partial settlement window, the transaction is considered within this processing step.

If a partial release request cannot be (fully) executed on the business day, the partial release process is stopped, and the underlying instruction is set on hold.

Partial release requests (creation and deletion) can be instructed via MT530 using Xact via Swift or Xact File Transfer and can be instructed in Xact Web Portal.

LuxCSD will inform the client and counterparty that the instruction was initialised by T2S. In this case the related MT548 will be transmitted.

Partial settlement in T2S

During the partial settlement windows, LuxCSD offers partial settlement capabilities if instructions are flagged for partial settlement. T2S will attempt to settle partial quantities as they become available on the account.

Clients can use the following four partial settlement indicators in their delivery and/or receipt instructions:

- NPAR - Partial settlement is not allowed.
The instruction will not be taken into account for partial settlement. Partial settlement is not possible if one instruction holds the NPAR indicator.
- PART - Partial settlement is allowed.
The instruction will be taken into account for partial settlement.
- PARQ - Partial settlement is allowed but must satisfy a minimum quantity of securities.

(Threshold: quantity equals minimum settlement unit specified within the T2S securities static data)

A threshold in “quantity” means that the partial settlement cannot take place for a quantity lower than the specified value.

The threshold is checked by T2S.

- PARC - Partial settlement is allowed but must satisfy a cash value minimum. PARC is not allowed for free of payment instructions.

(Threshold: value defined within the static data by the ECB)

A threshold in “cash value” means the partial settlement cannot take place for an amount lower than the defined value. The threshold is defined based on the securities ISIN and the settlement amount currency.

The instruction can be partially settled if the available settlement amount is above the applicable threshold defined by the ECB.

The threshold is checked by T2S.

If both parties allow partial settlements with different indicators the default threshold is applicable:

- The default threshold for free of payment instructions is PARQ (for all combinations);
- The default threshold for against payment instructions is PARC. However, if both parties had entered PARQ, partial settlement is performed on the quantity threshold (and for all other combinations PARC applies).

A matched pair of settlement instructions is eligible to partial settlement, when these settlement instructions are entered by the T2S parties with the following characteristics:

- They are related to free of payment or delivery against payment or delivery with payment instructions;
- The partial settlement indicator is not set to “No” in any of the Settlement Instructions;
- They are not linked to any other settlement instruction or settlement restriction by the T2S parties by a link type WITH, AFTE, BEFO, INFO or by a pool reference.

The threshold used with the codes PARC or PARQ is set:

- By T2S Actors from the content of their Settlement Instructions for the instruction type and instruction threshold type,
- By the T2S Operator inside the Static Data for the applicable threshold in cash value. This parameter is common to all T2S Parties, and set per T2S settlement currency, and separate for unit-quoted or nominal quoted ISIN by those in charge of the administration of the relevant ISIN in the Static Data for the applicable threshold in quantity.

In T2S, partial settlement is only applied in dedicated partial settlement windows.

Within these windows all transactions that are pending due to lack of securities or cash and hold a positive partial settlement indicator are included in the partial settlement processing.

When an instruction is partially settled in T2S clients receive a settlement confirmation (MT54x, MT536) and an MT548 for the remaining part.

Instruction specifications

The partial settlement indicator can be assigned in MT540-MT543 (ISO 15022) instructions.

If not specified T2S assigns PART to the instruction. For the detailed description, please refer to the T2S documentation issued by ECB.

T2S allows the modification of the partial settlement indicator during the instruction lifecycle.

MT530 must be used to modify partial settlement details of an existing instruction. In the MT530 the settlement condition indicator 22F::PRTL// NPAR or PART is used.

The codes PARC or PARQ are not recognised by ISO15022, it must be used after the Data Source Scheme (DSS) CEDE or LUXC.

The following aspects need to be considered for partial settlement:

- Whether partial settlement will be applied or not depends on the partial settlement indicator set within the instruction;
- The T2S partial settlement functionality is only applied if both counterparties have flagged their instructions for partial settlement;
- Partial settlement applies only when full settlement is not possible due to lack of securities or cash. T2S will perform partial settlement according to the available position after analysing the partial settlement indicator in the instruction;
- The settlement instructions are submitted to a full settlement attempt before being submitted to a partial settlement attempt;
- Partial settlement is only applied in dedicated partial settlement windows; T2S attempts to settle the maximum quantity of securities taking into account:
 - The securities position on the deliverer's SAC;
 - The cash resources available on the recipient's DCA;
 - A threshold (minimum amount) of the securities quantity (Nominal/Unit) or cash value.
- The partial settlement indicator can be set to delivery and receipt instructions;
- Partial settlement is applicable to intra-CSD and cross-CSD instructions;
- Partial settlement is not applied if instructions are linked to any other settlement instruction with link type "Before", "After", "With" or via pool reference;
- Partial settlement is not applied if the transaction undergoes a process where a CoSD Hold is used.
- The unsettled remaining part of a partially settled settlement instruction can be cancelled.

Partial settlement account setup

LuxCSD clients cannot flag their account to have a default non-partial settlement flag. T2S will process partial settlement as default unless the qualifiers mentioned under the section "Instruction Specifications" are introduced at instruction level.

3.3 Settlement processing of external transactions

Trades with counterparties in domestic markets outside T2S (that is, there is no CSD in T2S involved), supported using a LuxCSD direct link to the issuer CSD, are referred to as "external transactions". External transactions are supported free of payment only. The specific transaction types to be used and their settlement timing may vary according to the market requirements and instrument type. Further details are given in the respective Market Guide.

Instruction deadlines

The instruction deadlines for external securities transactions are given, in both CET and local times, for each domestic market in the respective Market Link Guide within the respective Market Guide on the LuxCSD website under Products & Services / Market Coverage.

CET instruction deadlines take daylight saving time (DST) changes around the world into account. Therefore, the CET deadline automatically adjusts to maintain a consistent local market deadline.

Important Reminder: As part of LuxCSD's internal compliance procedures, all incoming client instructions will be automatically scanned before entering transaction processing. Instructions that are internally flagged as requiring further manual investigation are set to status pending, with such status immediately reported to the client via their chosen media channel(s), until either being manually released for processing or rejected. In order to ensure that instructions being investigated do not miss the applicable deadlines, clients are advised to input instructions at least 15 minutes before the associated deadline.

For consolidated lists of instruction deadlines, in CET only, and the cash and securities holidays in the domestic markets, please refer to www.clearstream.com, under Key Documents / Reference Data.

Late instructions

In general, LuxCSD will not consider, in a given settlement processing, any instruction received after the specified deadline for that processing.

Cancellation of instructions

Any specific rules for the cancellation of unsettled (unmatched or matched) external transactions with domestic counterparties are given in the respective Market Guide.

The settlement day

Settlement processing cycles

The external settlement processing may start in different processing cycles. Further details are given in the respective Market Guide.

Settlement finality

Deliveries of securities to or from a domestic counterparty are final depending on local market regulations and practices.

Settlement Date (SD)

External settlement instructions with counterparties in domestic markets are considered for release to the appropriate domestic market or clearing system in time for them to be settled, upon successful provisioning, on the requested settlement date in the domestic market:

- For deliveries, the securities provision is debited from the client's relevant LuxCSD account position.

- For receipts, the client's receipt instruction is released and the credit of securities on the relevant LuxCSD account position take place upon confirmation of settlement in the domestic market.

Securities provision check

It is the client's responsibility to ensure the timely availability of securities provision as appropriate on the relevant account positions.

For external settlement, securities provision must be available on the account with LuxCSD.

Matching requirements

Matching of External transactions takes place at the issuer CSD in accordance with the requirements of that CSD. Further details are given in the respective Market Guide. LuxCSD does not accepted already matched instructions for settlement at the issuer CSD.

Hold/Release for securities settlement instructions

The Hold/Release mechanism enables clients to temporarily hold back a securities transaction from settlement, even securities provision is available, and to release it only when settlement is desired.

Further details on the service available are given in the respective Market Guide.

Partial settlement

Partial settlement may be available at the issuer CSD. Further details on the service available are given in the respective Market Guide.

3.4 Settlement finality

According to the Articles 39 (2) and 39 (3) of the CSDR, a CSD shall:

- ensure that each securities settlement system, that it operates defines the moments of entry and of irrevocability of transfer orders in that securities settlement system in accordance with Articles 3 and 5 of Directive 98/26/EC of the European Parliament and of the Council of 19 May 1998 on settlement finality in payment and securities settlement systems, as amended ("SFD").
- disclose the rules governing the finality of transfers of securities and cash in a securities settlement system.

The SFD has been implemented under Luxembourg law by the law of 10 November 2009 on payment services, as amended (the "**Payment Services Law**").

In accordance with Article 111 (1) of the Payment Services Law, the purpose of this section is to provide information and to define the securities settlement system rules applicable to the processing of the instructions, in particular to set out the rules determining the ability of a client to revoke or amend its settlement instructions and the moments in time when the instructions become irrevocable, binding and unconditional.

Moments of entry, irrevocability and finality of instructions

T2S

For the purpose of this sub-section in relation to settlement and instructions in T2S, the following terms and expressions shall be read as follows:

- "insolvency proceedings" or "insolvency" refers to any collective measure provided for in any laws governing any clients, either to wind up a client or to reorganise it, where such measure involves the suspending of, or imposing limitations on, transfers or payments.
- "transfer orders" shall refer to any instructions:
 - by, or on behalf of, a client holding a DCA operated by a central bank, to place at the disposal of a recipient an amount of money by means of a book entry on the account of another client holding a DCA operated by the same or another central bank, or any instruction which results in the assumption or discharge of a payment obligation as defined by the Governing Documents; or
 - by a client to transfer the title to, or interest in, a security or securities to another client or a participant to any other CSD using the T2S platform, by means of a book entry in a register or otherwise.

The moments of entry and irrevocability are the moments in time defined by the T2S platform.

- **Moment of entry**

For any instructions to be settled on the T2S Platform that are subject to matching shall be deemed entered into the system at the moment at which such transfer orders have been declared compliant with the technical rules of T2S by the T2S platform.

The occurrence of the moment of entry of the transfer orders are fully automated, identifiable and retrievable in T2S.

The moment of entry (that is, acceptance timestamp) of instructions in T2S is reported to clients via the means agreed by the clients for T2S services (such as Xact Web Portal or Swift statement).

- **Moment of irrevocability**

Any instructions to be settled on the T2S Platform shall be deemed irrevocable at the moment they have been given a “matched” status on the T2S Platform.

Matched T2S instructions can only be bilaterally cancelled. Clients cannot cancel their matched instructions unilaterally, even if the requested settlement date has not been reached.

Once both counterparties have sent their cancellation requests, both instructions are immediately cancelled and reported accordingly. Until T2S receives the cancellation requests from both counterparties, settlement will continue to occur.

The occurrence of the moment of irrevocability of the transfer orders are fully automated, identifiable and retrievable in T2S.

The moment of irrevocability (that is, matching timestamp) of instructions in T2S is reported to clients via the means agreed by the clients for T2S services (such as Xact Web Portal or Swift statement).

- **Moment of finality**

The moment of finality is the moment as from the settlement become irrevocable and enforceable between the parties and it corresponds to the moment in time when the transfers, i.e. the credit and debit of the securities and cash in the accounts, are irrevocable, binding and unconditional.

Regarding T2S instructions, as soon as the transfer orders are irrevocable as described in the above paragraph and with this binding matching in the relevant accounts, the transfer orders will then be processed in T2S for settlement to become final.

Any matched instruction that has not been settled and has not been bilaterally cancelled will remain in the system for further reprocessing attempts until such instruction is successfully settled or the cancellation requests are received from both counterparties.

When LuxCSD is informed of an insolvency proceeding of a client, any transfer order impacted by such insolvency proceeding which have been entered into LuxCSD system after the moment of being informed shall not be submitted for settlement, unless required to do otherwise by law, a competent court, an administrative authority or the insolvency trustee.

If a transfer order deemed impacted by the above insolvency proceedings of the holder of a DCA (either a client or the holder of the account designated by the client), LuxCSD will follow the instructions given by the central bank operating such DCA with a view to comply (or allow the central bank to comply) with any orders that the central bank may receive from a competent court, administrative authority or the insolvency trustee.

Final instructions in T2S are reported to clients as settled via the means agreed by the clients for T2S services (such as Xact Web Portal or Swift statement).

External instructions

Transactions settling with a domestic counterparty (that is, in the context of CSD links) are considered by LuxCSD as relating to External Instructions for the finality of deliveries of securities. These can be settled in the domestic markets free of payment. Please refer to the respective Market Guide for further details.

For the purpose of this section, “Depository” shall refer to another central securities depository (CSD) (or a securities settlement system (SSS) operated by a CSD, that is, a linked issuer SSS). For the avoidance of doubt, the term “Depository” shall be understood as the entity with which LuxCSD has its securities account for the deposit of the securities on behalf of the clients.

- **Moment of entry, irrevocability and finality of external instructions**

The rules governing the moments of entry and the irrevocability of external instructions and the enforceability of deliveries of securities and cash to or from a domestic counterparty are defined by each of the Depositories or local issuer SSSs in accordance with the domestic rules applicable to such market. The irrevocability and enforceability of the External Instructions are then achieved in the books of the Depositories or local issuer SSSs. Please refer to the respective Market Guide for further details.

Once the external instructions are final (that is, irrevocable and unconditional) with the Depository or local issuer SSS and upon notice of credit/debit of the relevant account of LuxCSD with such Depository, LuxCSD will update the client accounts accordingly. As per article 7.2 of the law of 1st August 2001 on the Circulation of Securities, as amended, the clients acquire the interest in domestic securities as soon as the securities are credited to the securities account of LuxCSD with the Depository and before the credit to clients securities account.

- **Amendment and cancellation of external instructions**

For domestic markets in which matching is “binding”, an Instruction can only be cancelled upon bilateral agreement between the parties to the trade. External instructions that are final in the external market but not yet reported to clients as settled are final.

Any specific rules for the cancellation of unsettled transactions with external counterparties are given in the respective Market Guide.

3.5 Reports to clients

The new transversal function (Report Centre) will allow Xact Web Portal users to subscribe to reports, to manage the report subscription and access delivered reports. The user will be able to:

- Create a customised scheduled report by defining formats, delivery timing and frequency
- Group reports
- Duplicate an existing subscribed report.

LuxCSD clients will be able to use Xact Web Portal (the Report Centre functionality) to view and schedule reports, including T2S reports.

The Report Centre can be reached by the users of Xact Web Portal via the external Service/box ("Reporting and Monitoring") and the "Report Centre" domain group. It is composed of "Delivered Reports" (the user can search for an already generated report and view, download, print and export this report) and "Manage Report Subscription" (user can create new report subscription or change one report subscription created in the past) domains. Users can access the Report Centre also from various individual business services offering report services. By accessing the Report Centre from a particular Business Service menu in Xact Web Portal the content of the reporting pages will be automatically adapted to include only what is relevant to that particular service.

For Direct Connected Participants of T2S, whether in A2A (Application-to-Application) or in U2A (User to Application) mode, various reports are in place. Please refer to the following documents, which are available on the following site: <https://www.ecb.europa.eu/paym/t2s>:

- T2S User Handbook
- T2S User Detailed Functional Specifications (UDFS).

3.6 Settlement reporting under the SDR

LuxCSD provides a reporting which is in line with the requirements mentioned in Article 11 of the SDR and include the below features:

- Real-time information on matched instructions;
- Real-time information on pending instructions that can still be settled on intended settlement date with the reason why it is pending;
- Real-time information on failing instructions that can no longer be settled on the intended settlement date with the reason why it is failing;
- Real-time information on fully-settled and partially-settled instructions;
- Real-time information on cancelled instructions by the system or the client;
- Real-time information on if the instruction can still be partially settled;
- Real-time information on if the instruction is on hold.

3.7 Interest claims

LuxCSD adopts the ICMA Recommendation to its Rule 406, which applies to all interest claims against clearing agents. As a consequence:

- No claim shall be considered for amounts of less than EUR 100 or its equivalent in another currency;
- No claim shall be considered after a lapse of thirty calendar days from the date on which the transaction was actually settled.

These guidelines apply to all LuxCSD clients and transactions processed in all securities accepted in LuxCSD for T2S eligible securities.

3.8 CSDR Settlement Discipline Regime

Introduction

In relation to Regulation (EU) No 909/2014 of the European Parliament and of the Council of 23 July 2014 on improving securities settlement in the European Union and on central securities depositories (CSDR) and the specific requirements prescribing a "Settlement Discipline Regime" (SDR), LuxCSD herewith describes its services relevant for LuxCSD clients.

The information mainly covers:

- The calculation, application and reporting of daily settlement fails cash penalties and their subsequent monthly payment through LuxCSD, including penalties calculated and reported by the T2S penalty mechanism to LuxCSD;
- The relevant clients' reporting obligations towards LuxCSD for the execution of CSDR mandatory buy-ins, if and when applicable;
- Aspects of the settlement fails monitoring and measures agreed with relevant LuxCSD clients to improve their settlement efficiency.

Important note: LuxCSD clients are required to use Xact Web Portal to subscribe to receive Swift MT537 penalty messages or query penalties information online. Access to the Xact Web Portal is required to address penalties "appeals" to LuxCSD (exceptionally, LuxCSD may accept appeal requests raised via MT599). Further information can be found in the "Xact Web Portal User Manual".

Disclaimer: As described in detail in this chapter, various reference data used for the penalties calculation is based on data published and maintained in ESMA databases for which LuxCSD is not responsible for. Hence, LuxCSD cannot provide any representation or warranty that the relevant data used by LuxCSD is complete, accurate or up to date. As a result, LuxCSD will not accept any client appeals nor claims for damages in this regard.

Settlement fails cash penalties

The following chapters provide detailed information about the daily and monthly processing of SDR cash penalties for settlement fails on the T2S settlement platform. The T2S change request T2S CR654 available on the ECB website further describes the T2S penalty mechanism functionality.

Note: For external settlements outside T2S (for example, LuxCSD's link to NASDAQ CSD Iceland), LuxCSD processes cash penalties as reported to LuxCSD from the penalties Calculating CSD or agent/depository. In such cross-CSD settlement fails scenario, involving multiple CSDs, only the CSD where settlement actually takes place is responsible for calculating and applying the cash penalties. This CSD is referred to as the "Calculating CSD". LuxCSD, acting as an Investor-CSD, applies the daily amounts reported by the Calculating CSD and reports them afterwards to its own clients for processing. The local CSD's penalties system rules and schedules apply. Further information can be found in the Market Link Guides on the LuxCSD website.

Penalties lifecycle and business days calendar

The following scenarios apply:

- Daily events:
 - Calculation and application of cash penalties;
 - Daily reporting.
- Monthly events:
 - Appeal period;

- Monthly reporting of "global net amounts" (GNA) to be paid or received;
- Actual collection and distribution of "global net amounts".

The illustration below summarises the lifecycle of the cash penalties.

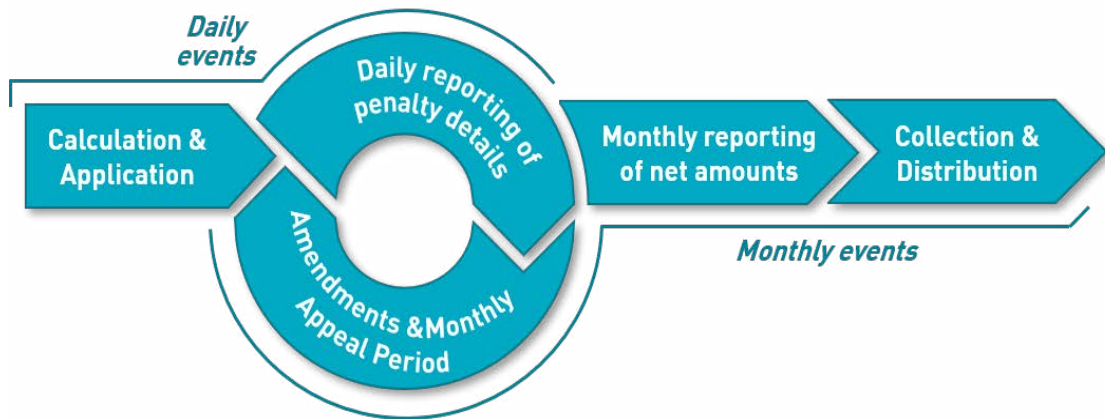

Figure 3-3. Daily and monthly events

Business days (BDs) calendar

Business days are those days on which an instruction can settle that depends on:

- The T2S settlement system calendar.
- The payment calendar of the relevant currency (only relevant for against payment settlement instructions).

BDs are only relevant for the application of daily events defined below.

LuxCSD, as T2S-In CSD, follows the T2S calendar. Business days are all days where a settlement instruction can settle in T2S. Business days for the T2S platform are all days where at least one currency is eligible¹ for cash settlement, except:

- Saturdays and Sundays;
- Other specific days such as 25 and 26 December and 1 January, for all types of settlement, as they are common closing days for the T2S-eligible currencies (currently EUR and DKK).

Based on the above, a penalty does not apply:

- For "free of payment" instructions: For the days when T2S is closed.
- For "against payment" instructions: For the days when T2S and/or the payment system of the relevant T2S currency is closed (if the cash leg is to be settled in the payment system of the relevant currency).

Common Penalties Business Days (PBDs) calendar

In the ECSDA "Penalties Framework", ECSDA Member CSDs agreed on common principles for a harmonised process in the definition and counting of "business days" for the CSDR penalties management. Such specific "business days" are called "Penalties Business Days" (PBDs).

PBDs are all days, except:

- Saturdays and Sundays;
- 25 December; and

1. See section 1.4.1 T2S Calendar in the T2S User Detailed Functional Specifications (UDFS).

- 1 January.

PBDs are only relevant for the application of monthly events defined below.

Penalties lifecycle

Daily events:

- Calculation and application:
Cash penalties are calculated and applied by T2S on each T2S business day.
- Daily reporting:
Cash penalties, including details on the calculation and related transaction, are reported by T2S on each business day. The daily report sent on a given business day includes cash penalties calculated and applied for the previous business day.

Monthly events:

- Monthly appeal period:
The appeal period for cash penalties starts on the day the cash penalty is calculated and applied. Such appeal period ends latest on the 10th PBD of the next calendar month¹.
Note: If T2S is closed on this day, the appeal period already ends on the previous PBD.
- Monthly reporting of global net amounts (GNA):
LuxCSD sends monthly reports for month M usually on the 14th PBD on month M+1 but as soon as the information is provided to LuxCSD and successfully reconciled.
See section "[Monthly reports](#)" for details.

- **Collection and distribution:**

Upon calculation of the GNA, LuxCSD generates "against payment instructions with zero quantity of securities" settlement instructions usually on the 15th PBD of M+1 to settle (that is, collect/distribute) the GNA on the 18th PBD of M+1.

If LuxCSD is closed on the 18th PBD then the collection and distribution process will take place on the next business day.

Cash penalties mechanism

As per Article 7(2) of CSDR, LuxCSD established a penalty mechanism for each securities settlement system it operates.

LuxCSD applies the T2S penalty mechanism for settlement fails occurring in T2S, hence, applies the daily amounts as reported by T2S and reports them as such to its clients.

For external settlements outside T2S (for example, LuxCSD's link to NASDAQ CSD Iceland), LuxCSD processes cash penalties as reported to LuxCSD from the penalties Calculating CSD or agent/depository.

1. If the LuxCSD client is identified as an "Investor-CSD" in LuxCSD the appeal period ends one day later.

LuxCSD	
Intra-CSD (LuxCSD-LuxCSD) Settlement instructions with a counterparty in LuxCSD	All cash penalties are calculated and applied by the T2S penalty mechanism .
Cross-CSD (LuxCSD-Other T2S-In CSD) Settlement instructions with a counterparty in another T2S-In CSD	All cash penalties are calculated and applied by the T2S penalty mechanism .
External settlement (LuxCSD- domestic market) Settlement instructions with a counterparty outside LuxCSD or T2S	For settlement with counterparties in a non-T2S CSD, cash penalties are calculated and applied as reported by the local CSD's penalty mechanism .

Figure 3-4. Penalty mechanisms.

The descriptions in the following chapters refer to the T2S penalty mechanism applicable to the LuxCSD settlement transactions. For external settlement, the local CSD's penalties system rules and schedules apply.

Instructions subject to cash penalties

The T2S penalty mechanism calculates and applies cash penalties for all OTC as well as stock exchange transactions settlement instructions in T2S that are:

- Matched; and
- Failing to settle (in part or in full) on and after their Intended Settlement Date (ISD).

This applies for all T2S instructions types:

- DVP/RVP: Delivery or receipt versus payment;
- DFP/RFP: Delivery or receipt free of payment;
- DPFOD/CPFOD: Payment free of delivery debit or credit;
- DWP/RWP: Delivery or receipt with payment.

The T2S penalty mechanism does not apply cash penalties for:

- T2S settlement restrictions;
- Technical settlement instructions generated by T2S, for example, for automatic T2S realignments;
- Settlement instructions populated with the qualifier "CORP" referring to a corporate action related settlement transaction

For cancellations:

- If a settlement instruction is cancelled prior matching, no cash penalty will be applied.
- If a settlement instruction is matched, cash penalties will be applied until the instruction is bilaterally cancelled.

Note: Penalties applied for transactions bilaterally cancelled after the ISD will not be removed.

Financial instruments subject to cash penalties

A financial instrument is considered by T2S as being eligible for cash penalties if:

- The ISIN is listed in the Financial Instrument Reference Data System (FIRDS) database, published by ESMA;
- And the ISIN is not in the list of exempted shares as per the EU Short Selling Regulation (SSR);
- And the "Securities Maintaining entity" T2S CSD has reported the ISIN as being SDR-eligible to T2S.

Note:

The FIRDS database includes non-EU securities traded or admitted to trading on an EU trading venue. Unless exempted, these non-EU securities are eligible for cash penalties when the actual settlement takes place in an EU/ EEA CSD.

In line with ESMA Q&As, changes in the ISIN scope as reflected in the ESMA databases apply for penalties that are calculated on ESMA database update publication date + 1 business day.

The FIRDS database may include financial instruments that were already matured. In such a scenario, T2S does only apply cash penalties for settlement fails on financial instruments that are matured up to maturity date - 1 business day.

Types of cash penalties

The T2S penalty mechanism distinguishes two types of cash penalties:

- Late Matching Fail Penalties (LMFP);
- Settlement Fail Penalties (SEFP).

Late Matching Fail Penalties (LMFP)

The T2S penalty mechanism calculates and applies LMFP to settlement fails on instructions eligible for cash penalties if such settlement instruction matches after the relevant settlement cut-off time of its ISD.

Figure 3 below illustrates whether LMFP applies or not. If matching occurs during:

- The period in green, then no LMFP applies;
- The period in red, then the T2S penalty mechanism calculates and applies LMFP (provided that the settlement instruction is eligible for cash penalties).

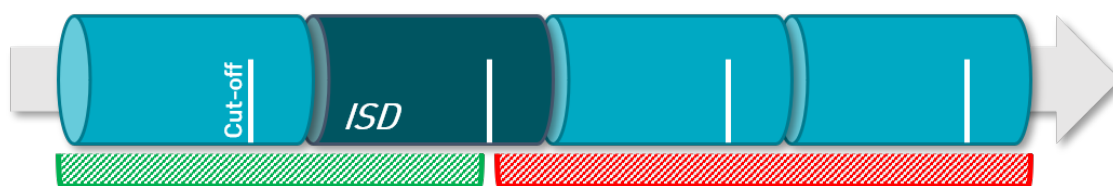

Figure 3-5. Eligibility to LMFP

For a given settlement instruction, the T2S penalty mechanism calculates and applies LMFP only once, that is, on the day the settlement instruction matches. Such LMFP applies retroactively to all business days, from the ISD to the matching date. For each past fail date a daily reference price applicable for the single fail date is used for the penalties calculation, that is, different reference prices may apply if the matching occurs more than one business day after the ISD.

The T2S penalty mechanism considers each business day where the settlement instruction was due to settle, from the ISD and until the actual matching date:

- Including such matching date if the instruction matched after the end of the relevant settlement cut-off;
- Excluding such matching date if the instruction matched before the end of the relevant settlement cut-off.

Figure 3-4 below illustrates the application of LMFP.

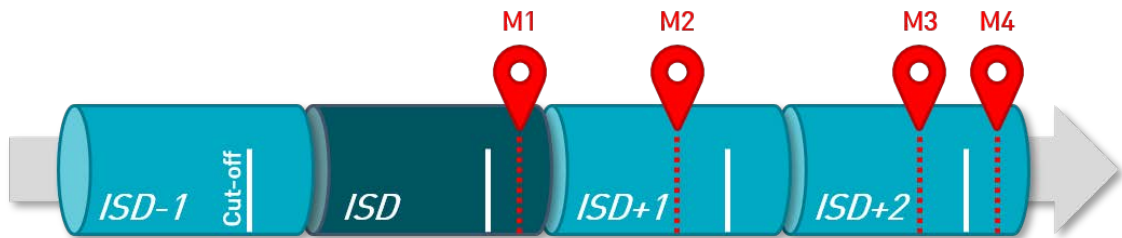

Figure 3-6. Application of LMFP

- If matching occurs on ISD after the cut-off time (M1), then the T2S penalty mechanism calculates one LMFP on ISD+1, applying to one single day, the ISD.
- If matching occurs on ISD+1 before the cut-off time on such ISD+1 (M2), then the T2S penalty mechanism calculates one LMFP on ISD+1, applying to one single day, the ISD.
- If matching occurs on ISD+2 before the cut-off time on such ISD+2, then the T2S penalty mechanism calculates one LMFP on ISD+2, applying to all business days from ISD until matching, excluding such matching day, that is, the ISD and ISD+1.
- If matching occurs on ISD+2 after the cut-off time on such ISD+2, then the T2S penalty mechanism calculates one LMFP on ISD+3, applying to all business days from ISD until matching, including such matching day, the ISD, ISD+1 and ISD+2.

The LMFP is charged to the LuxCSD client that was last to provide its settlement instruction (or modification to its settlement instruction, if applicable) for the period between the ISD and the day of instruction matching. The acknowledgement timestamp of the instruction is used to determine the failing client.

If both clients send their instructions late, after the end of the relevant settlement period of the ISD, only one of the two clients of a transaction is charged with the LMFP, that is, the client who was last to enter its settlement instruction. If settlement instructions are entered by LuxCSD on behalf of its client(s), as it is the case for market claims, the same rule applies. In rare situations when the timestamps are identical, the securities delivering client will be charged by default.

LMFP applies even if the settlement instructions have been bilaterally cancelled after matching but before the end of the relevant settlement cut-off (in this situation, however, SEFP will not apply, see section "[Settlement Fail Penalties \(SEFP\)](#)").

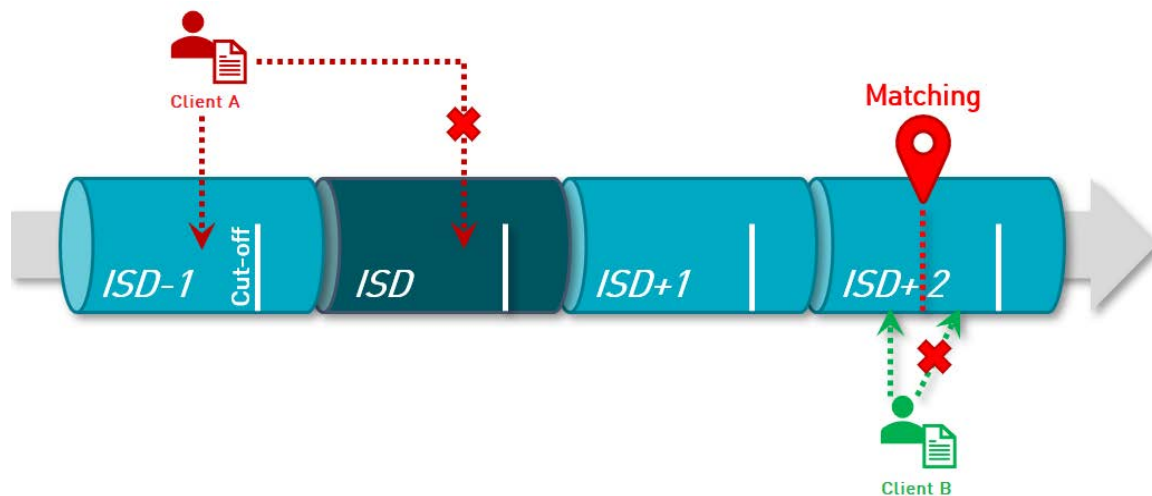

Figure 3-7. Application of LMFP on cancelled settlement instructions.

The T2S penalty mechanism may not apply LMFP in case of new settlement instructions resulting from a partially successful buy-in under certain conditions:

As required by CSDR, in case only parts of the failing securities delivery quantity were bought in, LuxCSD clients shall:

- Bilaterally cancel their initial failing settlement instruction; and
- Re-instruct for the remaining quantity of securities not bought-in.

When the new settlement instruction is re-entered by the client with the original (past) ISD, this settlement instruction would become subject to LMFP.

Only under the condition that both settlement instructions (that is, the securities receipt and delivery leg) contain the required "buy-in partially successful" indicator, the T2S penalty mechanism will not apply LMFP for the remaining quantity of securities. Please refer to the "Xact via Swift User Guide" for more information about the applicable "partially successful buy-in" indicator.

Settlement Fail Penalties (SEFP)

The T2S penalty mechanism calculates and applies SEFP to settlement fails if the settlement instruction:

- Is matched before the end of the relevant settlement period of the current business day;
- Has reached its ISD;
- Fails to settle (in part or in full) and remains to settle until the end of the relevant settlement cut-off of that business day (if not bilaterally cancelled).

For a given settlement instruction, multiple SEFPs may be calculated and applied, that is, one SEFP per business day when the settlement instruction fails to settle. The T2S penalty mechanism calculates and applies one SEFP at the end of each business day, considering the settlement status and reason at the end of the relevant settlement cut-off, provided that all three criteria mentioned above are fulfilled.

Figure 3-6 below illustrates the application of SEFP.

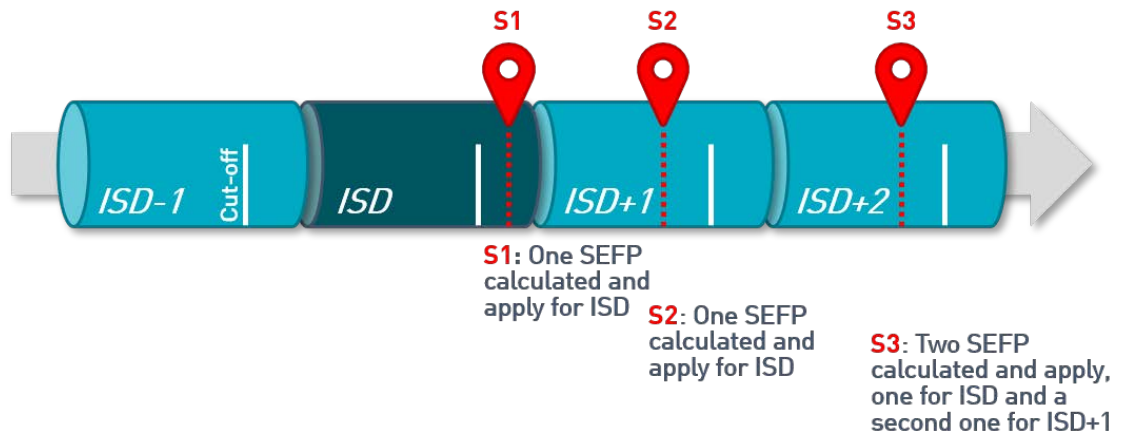

Figure 3-8. Application of SEFP.

- If settlement instructions fail to settle before the end of the relevant settlement cut-off on ISD, but settle overnight (S1), then the T2S penalty mechanism calculates and applies a SEFP on ISD.
- If settlement instructions fail to settle on ISD but settle on the next business day before the end of the relevant settlement cut-off, then the T2S penalty mechanism calculates and applies a SEFP on ISD, but not on ISD+1.
- If settlement instructions fail to settle on ISD and ISD+1 but settle on ISD+2 before the end of the relevant settlement cut-off, then the T2S penalty mechanism calculates and applies:
 - One SEFP on ISD for settlement fail on ISD; and
 - One SEFP on ISD+1 for settlement fail on ISD+1 but not on ISD+2.

The SEFP will be charged to the client:

- Having set the settlement instruction "On Hold";
- Being lack of securities, provided that no settlement instruction is "On Hold";
- Being lack of cash, provided that no settlement instruction is "On Hold" or lacks securities.

Note: If both settlement instructions are "On Hold", then both parties to the transaction will be charged with a SEFP to be paid to the counterparty. The different calculation methods described in section "[Types of cash penalties](#)" for settlement fails on deliveries and receipts against payment apply.

The table below summarises the party to the transaction that is to be charged with the SEFP, depending on the settlement fail reason:

Instruction	Buyer	Seller
Settlement instruction set "On hold" by the...	The Buyer must pay an SEFP to the Seller.	The Seller must pay an SEFP to the Buyer.
Note: when both, Seller and Buyer put their instruction "on hold", a SEFP applies to both.		
Lack of securities from the Seller	N/A	The Seller must pay an SEFP to the Buyer.
Lack of securities from the Seller and Instruction set "On hold" by the Buyer	The Buyer must pay an SEFP to the Seller.	N/A
Lack of cash from the Buyer	The Buyer must pay an SEFP to the Seller.	N/A
Lack of cash from the Buyer and Instruction set "On hold" by the Seller	N/A	The Seller must pay an SEFP to the Buyer.
Lack of securities from the Seller and lack of cash from the Buyer	N/A	The Seller must pay an SEFP to the Buyer.

Figure 3-9. Identification of the client to be penalised.

Calculation and application of cash penalties

The T2S penalty mechanism applies a calculation method that is depending on the **type of settlement instruction** of the client causing the settlement fail.

The table below describes the different penalties calculation methods:

Calculation Method	SECU	MIXE	CASH	BOTH
Formula	Security Penalty Rate X Quantity of undelivered securities X Price of the security for the relevant business day	Cash Discount Penalty Rate X Quantity of undelivered securities X Price of the security for the relevant business day	Cash Discount Penalty Rate X Amount of cash failed to be delivered	SECU + CASH
Type of settlement instruction of the failing client	<ul style="list-style-type: none"> • DVP • DFP • RFP 	<ul style="list-style-type: none"> • RVP 	<ul style="list-style-type: none"> • DPFOD • CPFOD 	<ul style="list-style-type: none"> • DWP • RWP

Figure 3-10. Determination of the calculation method.

Note: For partial settlement, the cash penalty amounts are calculated based on the remaining quantity of securities to be settled.

Security penalty rates

The Security Penalty Rate is the fixed rate applied for settlement fails due to "lack of securities", depending on:

- The CFI-classification of the relevant financial instrument;

- The liquidity indicator of the relevant financial instrument;
- Whether the underlying securities trade occurred on a SME Growth Market, or not.

Considering the above-mentioned criteria, the Security Discount Penalty Rates as published by ESMA are applied by T2S penalty mechanism:

Type of settlement fail	Classification of the security (CFI Code)	CSDR Classification	Liquidity Indicator	Traded on a SME Growth Market	Penalty Rate (in bps)		
Lack of securities	E*****	SHRS	True	No	1.00		
			False	No	0.50		
			n.a.	Yes	0.25		
<i>(The applicable Penalty Rate is referred to as "Security Penalty Rate")</i>	DN**** D**T** D**C**	SOVR	n.a.	n.a.	0.10		
			D****, Except DN****, DY****, D**T** and D**C**	No	0.20		
				Yes	0.15		
			R*****	SECU	n.a.	No	0.50
					n.a.	Yes	0.25
			CE****	ETFS	n.a.	No	0.50
					n.a.	Yes	0.25
			C**** Except CE****	UCIT	n.a.	No	0.50
					n.a.	Yes	0.25
			DY**** Except DY*T** and DY*C**	MMKT	n.a.	No	0.20
n.a.	Yes	0.15					
TTN***	EMAL	n.a.	No	0.50			
		n.a.	Yes	0.25			
Other	OTHR	n.a.	No	0.50			
		n.a.	Yes	0.25			

Cash discount penalty rates

The Cash Discount Penalty Rate is the rate applied by the T2S penalty mechanism for settlement fails due to "lack of cash", depending on the underlying T2S-eligible settlement or payment currency.

The applicable Penalty Rate is referred to as "Cash Discount Penalty Rate", that is the official interest rate for overnight credit charged by the central bank issuing the settlement currency with a floor of zero.

Note: For EUR, the "marginal lending facility rate" defined by the European Central Bank (ECB) and published on its website, divided by 360, is used.

Liquidity indicator

The liquidity indicator is a binary classification of securities applying only when the financial instrument type of the security derived from its CFI code is "SHRS".

The information on whether the share is considered a liquid or an illiquid share is derived from the ESMA FITRS database and applied by T2S penalty mechanism for an ISIN as reported to T2S by the "Securities Maintaining entity" T2S CSD.

If settlement fail applies to a share and the liquidity indicator for the share is not available or the instrument type category is unknown, then it will be considered as "illiquid".

SME Growth Market transactions

The T2S penalty mechanism applies a lower security penalty rate, if the transaction in the financial instrument identified in the settlement fail was actually traded on a SME Growth Market.

Such security penalty rate is applied only if:

- Both instructions show the same "place of trading" four-digit Market Identifier Code (MIC); and
- The trading venue identified in the field is included in the latest available list of SME Growth Market Trading Venues maintained and published by ESMA (i.e. to be considered by T2S; the SME MIC must be listed in the ESMA database on the day the penalty is calculated).

Daily reference price

The T2S penalty mechanism applies the reference price of the security for the business day when the settlement instruction actually failed to settle:

- For shares and similar instruments, the reference price is the closing price of the "most relevant market in terms of liquidity".
- For other securities, the reference price is the closing price of the trading venue with the highest turnover.

The applicable prices for an ISIN are reported to the T2S penalty mechanism by the responsible "Securities Maintaining entity" T2S CSD

If the cash penalty is a LMFP applying on multiple days, then the T2S penalty mechanism calculates the LMFP, applying the relevant reference price for each applicable day. If the LMFP applies on business days more than three months in the past, then, for those days, the T2S penalty mechanism applies the oldest available reference price, the three-months old price¹.

The T2S penalty mechanism calculates and applies computed cash penalties:

- For settlement instructions against payment, in the currency of the cash leg of the settlement instruction;

1. Any price used for the penalty calculation must not be older than the entry into force date of the CSDR Settlement Discipline Regime, that is, 1 February 2022.

- For free of payment settlement instructions:
 - Either in the currency of the underlying security if the Settlement Type is "nominal"; or
 - In the currency of the daily reference price if the Settlement Type of the underlying security is "unit".

If the currency is DKK, then T2S checks whether the BIC of at least one of the Counterparty CSDs is in the "List of CSDs with penalty computation in non-Euro settlement currencies for FOPs". If this is the case, then T2S will compute the cash penalty in DKK, otherwise, it will be calculated in EUR.

Note: LuxCSD does currently does not offer T2S settlement with counterparties in the Danish CSD Euronext Securities Copenhagen or against payment settlement in DKK, hence, no penalties in DKK apply.

If the currency derived by T2S is not a T2S-eligible currency, the penalty is calculated in EUR.

Update of a cash penalty

A change of the reference data used for the calculation of a cash penalty may be considered by the T2S penalty mechanism maximum until, and including, the 12th PBD of the next month.

When reference data needed to calculate a penalty becomes available only after the appeal deadline ended, such new penalty (NEWP) will still be considered by T2S in its daily and monthly penalties reports.

Unless a cash penalty can no longer be modified (i.e. is inactive or has been removed), the T2S penalty mechanism automatically re-calculates existing and active cash penalties impacted by a change in the reference price of a security for the relevant business day the cash penalty applies. Once re-calculated, the updated cash penalty is reported to the relevant clients via the daily reports described in section "[Daily reports](#)".

LuxCSD reports details on cash penalties exclusively via ISO 15022 MT537.

Important note: The penalty reports must be actively subscribed for and scheduled by the LuxCSD clients via Xact Web Portal. The same applies for querying penalties information via Xact Web Portal.

For details about the penalties reporting content, please refer to the connectivity manuals and user guides on the LuxCSD website.

Daily and monthly reporting of cash penalties

LuxCSD, using T2S reports, provides daily cash penalties reports, including details on the calculation and the related settlement instructions.

In addition, LuxCSD provides monthly reports usually on the 14th PBD (upon receipt from T2S), each month, considering active cash penalties calculated and applied on the previous month. These monthly reports include one monthly "Global Net Amount" (GNA) each, per counterparty-CSD and per currency, as well as the details of the relevant daily cash penalties composing the GNA.

LuxCSD reports details on cash penalties exclusively via ISO 15022 MT537.

Upon receipt of the LuxCSD reporting, if the client identifies during its reconciliation process, for example, inconsistencies, missing reporting or penalties and mismatches, this should be reported as soon as possible and before the end of the appeal period to LuxCSD via the standard communication channels or the Xact "appeals" function. The LuxCSD penalties reporting shall be considered as complete, correct and final after the end of the appeal period as no corrections can be done after that point in time.

Important note: The reports must be actively subscribed for and scheduled by the LuxCSD clients via Xact Web Portal. The same applies for querying penalties information via Xact Web Portal.

For details about the penalties reporting content, please refer to the connectivity guides on the LuxCSD website.

For cases where the daily penalties reporting from T2S is delayed, LuxCSD will include these penalties upon receipt and in the next available daily report batch. The monthly reports are provided to clients upon receipt and after successful reconciliation by LuxCSD versus the daily reports' data.

Daily reports

LuxCSD reports newly calculated cash penalties and amendments to already calculated cash penalties in two separate reports (covering new and modified penalties)¹.

LuxCSD clients can select the time(s) when to receive their daily reports (even though new and amended cash penalties are reported in two separate messages, the reporting times scheduled apply to both (that is, new and modified penalties) reports, for instance, it is not possible to receive only one of the two reports. More specifically:

- The report including new cash penalties only contains new cash penalties calculated or received since the last report.
- The report including amended cash penalties only contains amendments to cash penalties received by LuxCSD from T2S since the last report.

If for a given time scheduled by the LuxCSD client, there is no new and/or amended cash penalty to be reported, then the client will receive a "no activity" daily report (separate for "new" and "amended" penalties).

Note: LuxCSD clients directly connected to T2S (that is, DCPs) may opt to receive T2S reports from T2S directly, however, are also recommended to subscribe to at least the monthly reports from Clearstream (described in ["Monthly reports"](#) as this contains "global net amount" information, not provided by T2S.

Monthly reports

LuxCSD provides a monthly penalties report based on the report received from the T2S penalty mechanism

The table below summarises the usual reporting times.

LuxCSD	
Intra-CSD (LuxCSD-LuxCSD) Settlement instructions with a counterparty in LuxCSD.	On the 14th PBD of the month, between 08:30 and 09:30 CET (after successful reconciliation of the cash penalties calculated by the T2S penalty mechanism).
Cross-CSD (LuxCSD-Other T2S-In CSD)	On the 14th PBD of the month, between 08:30 and 09:30 CET (after successful reconciliation of the cash penalties calculated by the T2S penalty mechanism).
External settlement (LuxCSD domestic market) Settlement instruction with a counterparty neither in LuxCSD or T2S	For settlement with counterparties in a non-T2S CSD, after receipt and successful reconciliation of the cash penalties calculated by the local penalty mechanism.

Figure 3-11. Expected times for generation of the monthly reports.

If, for a given month, there is no active cash penalty to be reported, LuxCSD will not generate any "no activity" monthly report.

1. In contingency situations, T2S may report new penalties in their "updated penalties" report; such T2S penalties are reported by LuxCSD as "new" penalties.

Note: LuxCSD clients directly connected to T2S (that is, DCPs) may opt to receive T2S reports from T2S directly, however, are also recommended to subscribe to at least the monthly reports from Clearstream (described in ["Monthly reports"](#) as this contains "global net amount" information, not provided by T2S.

The LuxCSD monthly penalty MT537 PENA report does not include any "removed" penalties while the monthly aggregates in the Xact Web Portal currently include them. On the other hand, the MT537 PENA includes penalties with "computed" flag ("CMPU") "yes" and "no", while Xact Web Portal only includes penalties with "CMPU" flag "yes".

Monthly collection/distribution of cash penalties

"Monthly penalties collection/distribution" refers to the actual debit or credit of the monthly "global net amount(s)" (GNA) reported by LuxCSD to its clients (per counterparty-CSD and per penalties currency).

To collect the amounts due from or distribute the amounts entitled to be received by the LuxCSD clients, on the 18th PBD of the following calendar month LuxCSD initiates settlements towards its clients. The settlement instructions will be generated by LuxCSD in T2S on behalf of its clients on the relevant SAC (Securities Account) in T2S. The cash amount will be debited/credited on the standard client T2S DCA (Dedicated Cash Account) linked to such SAC.

CCP-related penalties are included in the penalty amounts processed.

The penalty amounts to be processed by the LuxCSD clients can be derived from the monthly penalty reports and "against payment instruction with zero quantity of securities" penalties settlement instructions. Penalties are not reported through the standard monthly client invoice.

Global Net Amount (GNA)

The GNA is the net amount of cash penalties to be paid (if negative) or received (if positive).

For each client, LuxCSD will net the amount of cash penalties:

- Per currency;
- Per Counterparty's CSD.

Each GNA reported by LuxCSD to clients will trigger two settlement instructions:

- If the GNA is negative, the amount is due to be paid by the client, then LuxCSD generates:
 - One instruction to debit the client's account;
 - One instruction to credit the relevant dedicated account of LuxCSD.
- If the GNA is positive, the entitled amount is to be received by the client, then LuxCSD generates:
 - One instruction to debit the relevant dedicated account of LuxCSD;
 - One instruction to credit the client's account.

For the penalties to be paid or collected at domestic markets level, these can be charged, collected and distributed to the clients once LuxCSD has successfully reconciled the domestic markets reports or actually received cash from the local market. Therefore, the payments can be delayed due to discrepancies in the cash penalties processes, notably with respect to the pay dates, applied in the various markets.

Late or missing cash funding from LuxCSD client(s)

If LuxCSD clients do not provide the required cash amount(s) in the currency(ies) as reported by LuxCSD in its monthly penalty report (see sections "Monthly collection/distribution of cash penalties" and "Monthly reports"), LuxCSD may contact and urge the failing clients for immediate feedback and action as well as written information on the mitigating actions taken to avoid future penalties payments fails due to the lack of cash funding to meet their penalties payments obligations.

If no T2S DCA or T2 RTGS DCA is linked to the LuxCSD client account, the related credit penalties payments will be cancelled or reversed immediately and the impacted client(s) be informed.

Important note: To avoid delays in the settlement or penalties payment processing, LuxCSD clients are required to comply with their obligations to timely and sufficiently fund their relevant T2S DCA to ensure the settlement instruction related to penalties can settle in the night-time settlement cycle for value date 18th PBD. Reference is made to Article 27 of the General Terms and Conditions and in particular to paragraphs 3 and 5. Clients are reminded that as failing participants, they have the obligation to pay the penalties in accordance with the CSDR and to fund their relevant accounts to enable LuxCSD to charge, collect and distribute the penalties to the counterparties. In the event of non-compliance with such payment obligations by clients, LuxCSD reserves the right to inform the relevant supervisory authorities in charge of the enforcement of penalties mechanism in accordance with Article 8 CSDR as well as to inform the impacted counterparty(ies).

For the payment of the monthly GNA, LuxCSD is redistributing the amounts actually collected on or after the intended pay date of the GNA. This means, in the event of late or insufficient cash funding of the T2S DCA of to be debited LuxCSD client(s), LuxCSD does not delay the cash distribution until all penalties to be collected have actually been paid by all to be debited LuxCSD clients. However, LuxCSD neither collects nor distributes partial GNAs: If the cash balance of a client's T2S DCA is insufficient to collect the full amount due, the debiting penalty PFoD instruction will remain pending until the full penalty cash amount was funded on the DCA. The same way, credit penalty PFoDs will only be settled in full or remain pending until LuxCSD has collected the required cash amount. As a final step, if not all debit penalties could be collected by LuxCSD, corrective PFoD instructions may be entered in the month following the intended pay date of the GNA to recalculate the GNAs by excluding all penalties of the failing LuxCSD client from the GNA calculation. Such recalculation may lead to debits of the counterparty(ies) of the failing LuxCSD client(s) that were credited although the cash could not be collected from this failing LuxCSD client (that is, their counterparty). The initial failing LuxCSD internal PFoDs will be cancelled and the impacted clients may bilaterally claim their counterparty for the penalties due. This process applies as well in the event of a client insolvency.

Details of the settlement instructions

Once LuxCSD has provided clients with their "global net amounts" to be paid or received, it will generate the settlement instructions on behalf of its clients. LuxCSD clients are not required to generate any settlement instruction relating to the collection and distribution process of cash penalties.

The settlement instructions are generated with Trade Date 16th PBD and Intended Settlement Date 18th PBD.

The Settlement Transaction Type is **"PAIR"**.

LuxCSD uses a single common "dummy" ISIN LU2128008567 for all settlement instructions relating to cash penalties.

LuxCSD generates the settlement instructions with the highest possible settlement priority.

The settlement instructions generated by LuxCSD are not eligible for partial settlement.

LuxCSD will report the matching and settlement status for instructions as per the client standard reporting (via MT548, if scheduled by the client, and/or Xact Web Portal).

Appeals

LuxCSD clients may submit Appeal requests to LuxCSD within a dedicated appeal period that starts once a new penalty has been reported by LuxCSD and ends latest on the 10th PBD¹ of the payment month.

1. If the LuxCSD client is identified as an "Investor-CSD" in LuxCSD the appeal period ends one day later.

According to the T2S penalty mechanism design, only "debit" penalties can be appealed by LuxCSD clients towards T2S; appeals related to "credit" penalties will be rejected by LuxCSD and not passed on to T2S but should be managed between the counterparties of the penalty.

LuxCSD clients can submit appeals for cash penalties reported by LuxCSD, regardless of the Calculating-CSD or system. LuxCSD clients shall submit appeal requests to LuxCSD in priority via Xact Web Portal. LuxCSD may, exceptionally, accept appeal requests raised via MT599 to the attention of PSG Settlement Operations.

Like the appeal requests submitted via Xact Web Portal, such MT599 requests shall be sent to LuxCSD within the dedicated appeal period that starts once a new penalty has been reported by LuxCSD and that ends latest on the 10th PBD of the payment month. The MT599 to be sent to CEDELULLXXX titled "ATTN: Settlement CSDR/ PSG – Penalties Appeal request" shall contain:

- Client Account Number;
- Penalty Reference;
- Penalty Calculation Date;
- Penalty Currency;
- Appeal Type (Amendment, Removal, Re-inclusion, Other);
- Appeal Reason.

For appeal acceptance, an updated penalty report will be provided automatically. Rejected appeals will be charged as usual, no further response to the requesting client will be provided.

Appeals need to include the applicable appeal reason or a proper description to be able to assess the validity of the appeal request. Appeals without sufficient (mandatory or optional) appeal reasoning information will be rejected without further processing. A financial instrument suspension from trading will not be considered by LuxCSD as valid appeal reason.

Note: It is neither possible for LuxCSD clients to raise nor for LuxCSD to process appeals after the end of the T2S or domestic CSD's appeal period. Hence, appeals should be raised as soon as the daily penalty information was made available to the LuxCSD clients and ensure appeals are regularly raised towards LuxCSD latest until the 5th PBD to allow for processing prior the end of the appeal period.

Any appeals received and processed by LuxCSD will ultimately either be in status:

"Accepted"

The appeal request is valid, and the relevant cash penalty has been amended accordingly, based on the information provided by the LuxCSD client; amended penalties will be reported and labelled as such by LuxCSD as "modified penalties"; or

"Rejected"

The investigation concluded that the appeal request is not valid, and the relevant cash penalty not amended; rejected appeals will not trigger a dedicated reporting.

Note that rejected appeals will be subject to charges as per the LuxCSD Fee Schedule and/or external fees (if applicable).

"Accepted" Appeals will lead either to the penalty:

Removal

- If insolvency proceedings are opened against the failing client.
- If settlement occurred on multiple platforms and one of the platforms was closed on the day the cash penalty has been calculated and applied.
- If the ISIN of the financial instrument is suspended from settlement due to a reconciliation issue.

- If settlement fail is due to a technical impossibility at (I)CSD level (for example failure of the infrastructure components, cyber-attack, network issues).
- Due to another reason (the client's appeal request is requiring a free-text description).

Re-inclusion

- The client's appeal request is requiring a free-text description.

Amendment

- The T2S penalty mechanism does not allow CSDs to send "amendment" requests. If LuxCSD clients are in disagreement with, for example, the reference data of a penalty calculated by T2S, the LuxCSD Client Service should be requested for investigation.

Reallocation

- This T2S functionality allows to re-allocate a LMFP from the instructing party to the delivering/receiving party to cater for cases when an "already matched" settlement instruction is sent late to T2S and, consequently, a LMFP is computed and assigned to the Instructing Party as both, the failing party and non-failing party. In case LuxCSD is not the Instructing Party, T2S cannot identify which settlement party of an already matched instruction is responsible for the LMFP. Therefore, reallocations are performed automatically upon request of the Instructing Party.
 - To initiate such process, LuxCSD clients shall use the appeal type "Removal", code "OTHR", and provide a free text description stating "T2S reallocation request".

Switch

- This T2S functionality caters inter alia for cases where a transaction is settled on multiple platforms, that is, where settlement on T2S depends on the fulfilment of a condition outside T2S. For example, when cash settlement takes place outside T2S while the settlement of securities takes place in T2S, conditional securities deliveries (CoSD) may be used by T2S Actors to block the securities in T2S until cash settlement takes place on the relevant platform. Depending on the CoSD configuration and the business scenario, T2S could compute and assign the penalty to the incorrect party (that is, to the delivering instead of to the receiving client or vice versa), for example, because the free-of-payment delivery in T2S is failing, while as it is due to the lack of cash of the counterparty on the external cash settlement platform. Hence, in order to allow the CSD to make the required ex-post correction, the CSD shall be able to swap the failing party and the non-failing party of the cash penalty.
 - To initiate such process, LuxCSD clients shall use the appeal type "Removal", code "OTHR", and provide a free text description stating "T2S switch request".

Please refer to the Xact Web Portal User Manual for further details about the submission and processing of Appeal requests.

Note: If an appeal request cannot be finalised before the monthly report generation, the penalty amount as reported by LuxCSD will be charged.

Buy-ins

If and when applicable, CSDR Article 7a obliges trading parties and CCPs to initiate buy-ins for failing settlements in any financial instrument in scope that cannot be settled within a certain time period. Trading parties shall arrange the buy-in themselves in line with prescribed SDR rules and reporting requirements. For CCP-cleared transactions, the CCP shall initiate the buy-in.

Despite the fact that LuxCSD has no role in the buy-in initiation process, CSDR requires to provide buy-in execution details for LuxCSD T2S settlement instructions failing that were subject to mandatory buy-in initiation according to CSDR.

Once the buy-in process has been actually executed, the execution details shall be provided to LuxCSD the LuxCSD client via a specific "MT530 "buy-in" message.

Please refer to the Xact via Swift user guide for details.

Important note: Any buy-in execution notifications are only used for the compliance of LuxCSD and its clients with the relevant CSDR regulatory reporting and record keeping requirements of CSDs. They do not trigger any buy-in initiation, execution, settlement or other "CSDR mandatory buy-in regime" related activities on the side of LuxCSD.

Monitoring Settlement Fails (settlement efficiency)

CSDR requires LuxCSD to measure its clients' individual settlement efficiency (on LuxCSD client LEI-level) to identify:

- The "Top 10" LuxCSD clients (by settlement transactions value and volume) that are failing to deliver securities/provide cash on ISD, including "late matching" fails, and report them to LuxCSD's regulator (CSSF);
- "Consistently and systematically failing participants" (that may ultimately be suspended from settlement by LuxCSD) comparing their settlement efficiency versus LuxCSD's overall settlement performance.

Note: As LuxCSD lacks the view on the LuxCSD clients' underlying clients settlement data, LuxCSD clients are encouraged to analyse the settlement behaviour as well as fail reasons, patterns and late matching situations at the level of their underlying clients.

LuxCSD is also obliged to publish anonymised transactions' fails and efficiency data to the public.

Note: Only settlement fails and caused by the client itself and subject to CSDR penalties are considered.

Top 10 failing clients identification and working arrangements

LuxCSD identifies the "Top 10 failing clients" by their settlement fails value and volume on a monthly basis in line with the ESMA fails reporting guidelines.

The following metrics are applied by LuxCSD:

LuxCSD client efficiency: The efficiency calculation by number and by value considers (per client LEI) all eligible instructions of the previous month with: $100 - (\text{sum of fails} * 100 / \text{sum of eligible instructions})$. Eligible instructions include all matched instructions during the calculation period (that is, matched instructions settled or cancelled on or after ISD; instructions settled after ISD include all failure reasons (lack of securities/cash and beyond). Fails for the client's efficiency are restricted to matched instructions settled after ISD due to the single client lack of cash (when receiving client) or lack of securities (when delivering client). Instructions cancelled or on-hold after ISD are counted in fails and are included in the number and value of eligible instructions.

Clients whose fails represent at least 0.1% (that is, those clients that, according to the CSDR text, "have the most significant impact on the securities settlement system") of the total settlement instructions fails by volume or by value in LuxCSD and limited to ISINs subject to SDR will be subject to "working arrangements". This means LuxCSD will notify the clients via email requesting them within two weeks to analyse and provide the main reasons for their settlement fails and confirm which LuxCSD services or other measures they intend to apply as concrete means to enhance their settlement efficiency. The client feedback will be passed on to LuxCSD's regulator.

Note: When LuxCSD itself (acting as Investor-CSD in another CSD on behalf of the LuxCSD clients) is identified as a "Top 10" failing client, the underlying LuxCSD clients will be identified and approached by LuxCSD to provide feedback according to the local CSD's requirements.

Consistently and systematically failing clients identification

Annually, LuxCSD identifies "consistently and systematically failing participants" (that is, the LuxCSD client efficiency rate must "at least be 15% lower than the rate of settlement efficiency of the securities settlement system, during at least a relevant number of days over the 12 previous months") to potentially suspend these clients from settlement.

The following metrics are applied by LuxCSD:

1. LuxCSD settlement system efficiency: The efficiency calculation by number and by value considers all eligible instructions of the previous 12 months with: $100 - (\text{sum of fails} * 100 / \text{sum of eligible instructions})$. Eligible instructions include all matched instructions during the calculation period (that is, matched instructions settled or cancelled on or after ISD. Fails include only matched instructions settled after ISD due to the client's lack of cash or securities or "on hold").
2. Consistently and systematically failing clients: The efficiency calculation by number and by value considers (per client LEI) all eligible instructions of the previous 12 months with: $100 - (\text{sum of fails} * 100 / \text{sum of eligible instructions})$. Eligible instructions include all matched instructions during the calculation period (that is, matched instructions settled or cancelled on or after ISD. Fails for the client's efficiency are restricted to matched instructions settled after ISD due to the single client lack of cash or lack of securities. Instructions cancelled or on-hold after ISD are counted in fails and are included in the number and value of eligible instructions. The number of failing days is the number of business days where the client's efficiency "is at least 15% lower than the rate of settlement efficiency of that securities settlement system, during at least a relevant number of days over the 12 previous months" (the "threshold", that is, the LuxCSD settlement system efficiency rate - 15%). The client's efficiency is computed for every business day, so the computation is restricted to clients below the threshold. The "relevant number of days" is 10% of the number of business days between the reception date of the "oldest" instruction (not just fails) and the reception date of "newest" over the last 12 months. For each client (LEI) below the threshold, the "success rate" by number or value will be calculated.

LuxCSD clients whose fails represent at least 3.5% of the total settlement instruction fails by volume or by value in LuxCSD will be contacted to assess the fail reasons and apply actions to avoid or limit re-occurrence. If the client LEI appears in the LuxCSD-internal "Top 10" failing clients list of the fourth quarter of the same year as well as in the forthcoming annual "suspension" report, LuxCSD may initiate the actual suspension of the client from settlement after consulting LuxCSD's regulator. The client's name as well as the suspension start date will be published in advance. For LuxCSD clients (including DCPs), LuxCSD will take the necessary measures to ensure that the relevant settlement instructions are blocked from settlement or new instructions received on or after the suspension date can no longer be entered by the client for T2S settlement.

This page has intentionally been left blank.

4. Cash settlement

All payments in relation to securities transactions with T2S-eligible securities and custody cash flows for T2S-eligible securities and currencies are settled via T2S.

LuxCSD clients are required to manage their cash via the T2S Dedicated Cash Accounts (DCAs) that they open at their discretion with a Central Bank. Clients must ensure that their T2S DCA is funded otherwise they will not be able to provision their against payment instructions.

LuxCSD has no access to a client's T2S DCA. LuxCSD must request the authorisation from the client to receive information about its DCA from T2S.

T2S Dedicated Cash Account Statement (MT940)

In order to assist T2S DCA holders to better reconcile the cash on their DCA, LuxCSD together with some Central Banks have defined a solution to allow them to receive the T2S message "camt.053 - Statement of Account" in the form of a Swift MT940 message called the "T2S Dedicated Cash Account Statement". The MT940 T2S Dedicated Cash Account Statement reports all cash movements (settlement and custody) of the T2S DCA including securities movements of the T2S Securities Accounts (SACs) linked to any of the Central Securities Depositories (CSD).

Please refer to "[T2S Dedicated Cash Account Statement \(MT940\)](#)" for further details.

4.1 Cash settlement through T2S

The cash settlement of securities transactions and certain Corporate Actions generally involves the following instruction types:

- Transfer of securities against payment in EUR: Delivery versus Payment (DvP), Receive versus Payment (RvP)
- Transfer of securities with payment in EUR: Delivery with Payment (DwP), Receive with Payment (RwP)
- Payment in EUR without transfer of securities: Payment Free of Delivery Debit (PFoD-DBIT), Payment Free of Delivery Credit (PFoD-CRDT)

These transactions can settle in T2S during night-time settlement (NTS) as well as during real-time settlement (RTS), until 16:00. In both cases, the cash is settled directly via a DCA linked to the respective Securities Account (SAC).

If a transaction cannot settle due to lack of cash, T2S will reconsider it for settlement in regular intervals during the day. That means that an increase of cash on the DCA is considered in a timely manner.

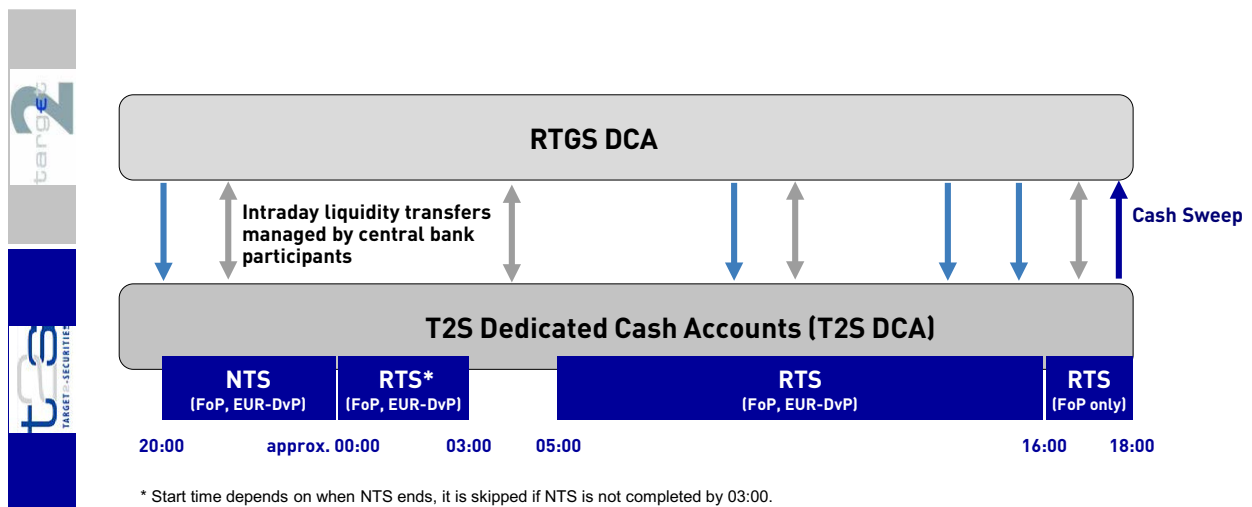

Figure 4-1. Settlement and cash-clearing cycles in T2S

4.2 Holiday handling

LuxCSD applies all holidays recognised by the T2 RTGS as non-cash settlement Business days. On such holidays, against payment securities settlement in LuxCSD will be ineligible.

Regular holidays for T2 RTGS are as follows:

- 1 January
- Friday before Easter Sunday
- Monday after Easter Sunday
- 1 May
- 25 December
- 26 December

4.3 Cash settlement outside T2S

LuxCSD provides only free of payment external settlement on securities held on CSD links outside T2S.

4.4 T2S auto-collateralisation and client-collateralisation

T2S auto-collateralisation is a functionality provided by T2S. It allows the generation of additional intraday cash liquidity in case of insufficient liquidity for the settlement of securities transactions. LuxCSD supports T2S auto-collateralisation.

For the provision of intraday credit two types of T2S auto-collateralisation are offered by the Eurosystem:

- Central Bank collateralisation (afterwards referred to as "auto-collateralisation"):
 - Offered by a NCB (credit provider);
 - Covering the lack of cash on a T2S DCA;
 - Providing the possibility for secured intraday credit from NCBs;
- Client-collateralisation:
 - Offered by a payment bank (credit provider);
 - Covering insufficient external guarantee headroom as defined within the CMB for the payment bank's client;
 - Providing the possibility for secured credit line from payment banks.

Whereas auto-collateralisation increases the available cash liquidity on a DCA, client-collateralisation increases the credit limit a payment bank grants to his client. With the migration to T2S, LuxCSD supports both auto-collateralisation (together with the NCBs) and client-collateralisation.

NCBs have to determine the collateral management procedure they want to use for their central bank collateralisation processes. LuxCSD supports the following collateral management procedures:

- Repo procedure:

The used collateral is transferred from the collateral providing account of the collateral provider to an (intraday) collateral receiving account of the credit provider.
- Pledge procedure:

The used collateral is transferred from the collateral providing account of the collateral provider to an (intraday) collateral receiving account of the collateral provider where it is pledged to the credit provider.

The BcL supports the pledge procedure for collateral management.

Note: In T2S, positions that can be used as collateral source for auto-collateralisation must be segregated from positions not to be used for this service on a source account. The source account can be held in any CSD whereas the pledge collateral account has to be in LuxCSD. The procedure is based "on stock" and "on stock plus on flow".

Intraday liquidity provided via the auto-collateralisation need to be reimbursed by the end of the against payment settlement timeline. If no reimbursement was initiated an automated reimbursement procedure is initiated by T2S at 16:30. If a reimbursement instruction cannot be partially nor fully settled on T2S, the NCB will balance the DCA. The credit line of the payment bank will be increased.

This page has intentionally been left blank.

5. New Issues

A comprehensive range of services is provided in connection with the eligibility assessment, issuance and distribution of new issues.

LuxCSD requires that all new issues are serviced by agents that are AML regulated financial institutions. Issuer agents (for example issuing and paying agents, principal paying agents, lead managers) will be expected to support the issuer in the eligibility and confirmation process and in some instances in the primary settlement. LuxCSD will assess all such entities as part of the eligibility process.

Acceptance of a prospective issuer or issuer agent on a particular issuance does not guarantee conditional acceptance for future issuances.

When accepting new issues, LuxCSD assists lead managers, lawyers and issuing agents. LuxCSD reviews issue structures and can provide additional information on operational procedures for specific features or requirements of new issues. LuxCSD also advises on the documentation of these procedures in the Offering Documentation upon submission for review.

For more particular details on LuxCSD's new issue services and procedures, and the advantages of using LuxCSD for the distribution of new issues, please consult your Relationship Officer or the New Issues department in Luxembourg.

LuxCSD offers services as Issuer CSD. Securities issued through LuxCSD may be issued under Luxembourg law or any other governing law. Furthermore, LuxCSD offers Investor CSD services for securities held at other CSDs.

LuxCSD as Issuer CSD provides services for T2S-eligible securities in global¹ or dematerialised format and covers:

- Debt instruments: money market instruments (for example, CP, CDs, MTNs), bonds, convertibles, asset-backed securities etc.;
- Equity instruments: warrants, ordinary shares, preferred shares etc.;
- Structured Products.

Counterparties in the distribution may be clients in LuxCSD or in a CSD holding an account at LuxCSD. Settlement of the primary market issuance is in CeBM therefore each direct participant must operate a T2S account or appoint a settlement bank that operates a T2S account or a DCA.

LuxCSD may also provide tailor-made services upon request. These services offer customised support to the issuing community to assist the market in becoming more efficient and in reducing risk.

Our Issuance team can provide the issuer and its agents with support throughout the issuance process via a variety of channels; daily contact via telephone, face to face meetings, and market advisory groups.

Before securities become available for secondary market settlement and for the custody management services of LuxCSD, the closing operations in new issues are processed by LuxCSD. The process of security issuance in LuxCSD is summarised below.

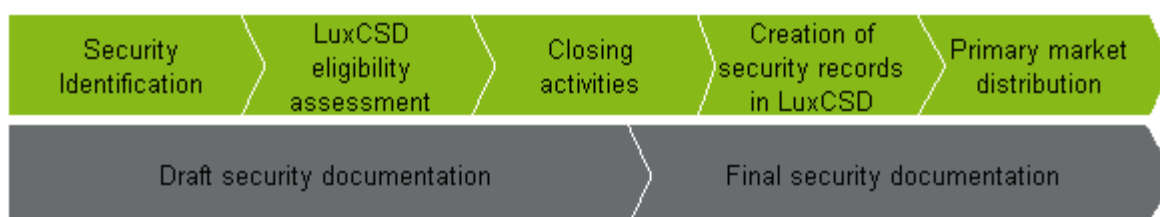

Figure 5-1. Security issuance process

1. Securities in semi-permanent global form or in definitive form are not accepted by LuxCSD.

For clients requiring further details of the issuance process, for example those who function as agent on behalf of issuers, please refer to the LuxCSD Operational Arrangements that are available on the LuxCSD website.

LuxCSD does not make any representation nor does it have any duty to monitor (i) the underlying commercial transaction or (ii) the compliance of the issuers to the Regulation (EU) 909/2014 on improving securities settlement in the EU and on central securities depositories (CSDR).

Note: Non-compliance with LuxCSD's procedures may result in the security not being made eligible for clearing and settlement, in particular, a security cannot be made eligible if not recorded in book-entry form in LuxCSD.

5.1 LuxCSD issued securities

LuxCSD provides the following legal and holding structures for the representation of eligible LuxCSD securities.

LuxCSD Bearer Global Note (LBN)

An LBN is a security represented by a global certificate that refers to the records of LuxCSD for evidence of the total indebtedness (that is, the Issue Outstanding Amount - IOA) of the issuer.

LuxCSD Registered Note (LRN)

An LRN is a security represented by a global certificate registered under the name of LuxCSD and recorded as such in the register maintained by an agent (the registrar) appointed by the issuer. The IOA or amount of securities issued in LuxCSD shall be maintained by the registrar and evidenced as such on the corresponding global certificate.

LuxCSD Dematerialised Note (LDN)

An LDN is a security represented by book entries in LuxCSD and recorded as such by LuxCSD acting as "Organisme de Liquidation" (OL).

5.2 LuxCSD principal agents

LuxCSD requires a LuxCSD principal agent (LPA) that is qualified by LuxCSD and appointed by the Issuer to support the issuance and distribution of, and to provide assistance for the asset servicing of, securities issued in LuxCSD.

The LPA:

- Is appointed by the Issuer;
- Receives mark-up/down instructions from the Issuer and communicates them to LuxCSD;
- Provides asset servicing assistance over the life of the security (for example, notification of unpredictable income and corporate action events, and tax assistance).

5.3 Existing securities not accepted in LuxCSD

LuxCSD can add existing securities not yet accepted provided that it can be determined that they are eligible. For this LuxCSD requires as much information as possible about the issue. Ideally, a copy of the documentation should be submitted. As with all new securities, LuxCSD will assess each for its eligibility from a legal, operational and tax perspective to ensure that LuxCSD can service the issue through its life.

5.4 How to obtain details about securities

The securities that are eligible for deposit in LuxCSD are available, with the name and code of the LPA for each issue, in Xact Web Portal.

This page has intentionally been left blank.

6. Asset servicing

LuxCSD provides clients with a full range of asset servicing for income and non-income events which consist of:

- Exchanges;
- Income services;
- Corporate actions services;
- Event notification and entitlement forecast;
- Payment management of asset servicing proceeds;
- Transaction management;
- Tax services;
- General Meetings Services.

Note: In accordance with the terms and conditions of an issue, custody operations may be subject to prior certification of beneficial ownership.

Additionally some instruction options or certifications may be available for specific account asset types only (own assets, client segregated or client omnibus accounts). The client must ensure that the current account asset type reflected in LuxCSD's systems is one that allows the type of instruction option or certification intended to be sent to LuxCSD with respect thereof. If LuxCSD receives instructions related to asset services which are incompatible with the account asset type defined for the instructing client account, LuxCSD reserves the right to reject or revoke such instructions at any time.

Unless otherwise stated, the term "global note" refers to a LuxCSD Bearer global Note (LBN). For further information on the definition of a LBN, please refer to [Chapter 5](#).

Note: Short Selling of income or corporate action proceeds is not authorised in LuxCSD. For further information, please refer to [Short selling of income or corporate action proceeds](#) on page 3-1.

While LuxCSD outsources the settlement of securities to T2S, the processing of asset services remains the responsibility of LuxCSD.

LuxCSD asset servicing covers both securities eligible in T2S and securities that are non-T2S eligible. Although most of the asset servicing processes are harmonised across both securities and account types, some processes have been adapted to T2S environment. This is mainly the case for payment management and transaction management which will be executed following the new rules.

The proceeds resulting from a corporate action on T2S eligible securities will be distributed into the T2S accounts of the LuxCSD client, the Securities Account (SAC) and Dedicated Cash Account (DCA) respectively.

The proceeds resulting from a corporate action on non-T2S eligible securities will be distributed into the related Clearstream Banking Luxembourg securities and cash accounts of the LuxCSD client. Those accounts will also be used to distribute the non-T2S eligible proceeds resulting from the corporate action on T2S eligible securities.

Securities for which LuxCSD offers investor CSD services through its link with CEU, may be denominated in a non-T2S eligible currency. In this case, cash proceeds resulting from a corporate action will be distributed into the related Clearstream Banking Luxembourg cash account of the client.

LuxCSD clients can access asset servicing processing and reporting via:

- Xact Web Portal;
- Xact File Transfer;
- Xact via Swift.

6.1 Exchanges

Exchange of a temporary global note for permanent global or definitive certificates

With the exception of the dematerialised securities, when a new issue is launched, the securities are represented by a temporary global note. On the exchange date, the temporary global note is exchanged either into a permanent global note (which normally remains in global form until final maturity), or into definitive certificates.

LuxCSD issued securities are deposited with the LuxCSD Vault for the safekeeping of the global note and a LuxCSD Principal Agent is appointed to assist with asset servicing.

While the issue is represented by a global note, all transactions in the security are executed on a book-entry basis only.

On the date agreed for the exchange, LuxCSD confirms the holdings in the temporary global note to the issuer's agent.

The holdings recorded on the exchange date serve as the basis for the exchange into a permanent global note or for the distribution of definitive certificates. Book-entry settlements in LuxCSD are unaffected by this procedure.

Exchanges into definitive certificates

Instructions for physical delivery of securities are maintained in suspense until the definitive certificates become available to carry out the transactions.

Definitive certificates are delivered by the printers to the trustee or to the fiscal agent for verification, and for authentication as may be required by the terms and conditions of the issue. As soon as the fiscal agent informs LuxCSD that definitive certificates are available, the exchange of the temporary global note into definitive certificates can be arranged. Securities in definitive form are not eligible in LuxCSD¹.

The Issuer Agent arranges for the delivery of the securities from the office of the fiscal agent to the LuxCSD Vault. When the LuxCSD Vault has received and accepted the definitive certificates, the Issuer Agent gives its authorisation to the LuxCSD Vault concerning the disposal of the temporary global note in accordance with the instructions of the Issuer Agent. The Issuer Agent instructs the LuxCSD Vault either to cancel the temporary global note or to return it to the issuer when the exchange is completed.

Restricted period for debt instruments (TEFRA D regulations)

Debt instruments are usually subject to sales restrictions and cannot be offered or sold to certain categories of investors. Such restrictions are usually temporary (although they may occasionally be permanent) and are defined in the terms and conditions of the issue.

Debt instruments eligible in LuxCSD are not usually registered under the Securities Act of 1933 of the U.S.A, as amended, and are therefore restricted for United States investors. The issuer of such securities may therefore decide to apply TEFRA D regulations.

According to the TEFRA D rules (which relate to the "Tax Equity and Fiscal Responsibility Act of 1982" for U.S. securities sold abroad), no U.S. citizen or anybody who has been resident in the U.S.A. for longer than 183 days may buy a TEFRA D security in the first 40 calendar days after the date of issue. TEFRA D restrictions are temporary, they apply for a specified period, called the "Restricted Period".

The Restricted Period ends upon the exchange of the temporary Global Note.

1. Securities in definitive form are defined as individualised physical securities as opposed to book-entry securities. Securities in definitive form are not supported by LuxCSD. In the case of an exchange into definitive securities, instructions need to be provided by the issuer (agent) for transfer to an alternative provider.

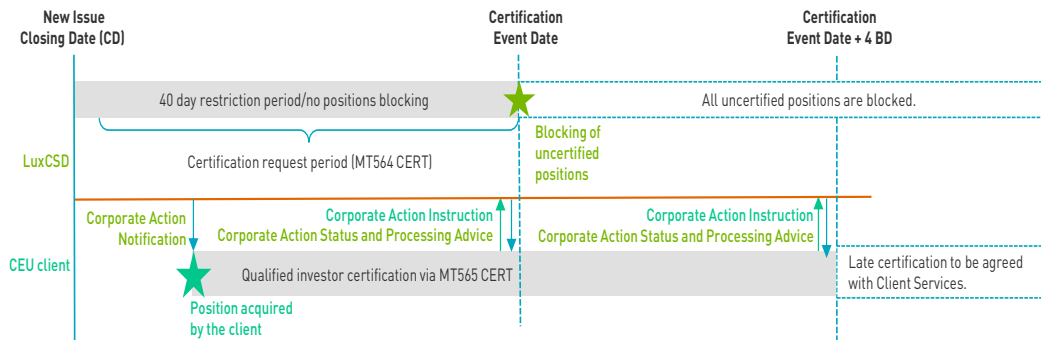

Figure 6-2. TEFRA D certification procedure

TEFRA D restrictions are temporary, they apply for a specified period, called the “restricted period”. The restricted period ends upon the exchange of the temporary global note.

In order to obtain payment on an interest coupon or to obtain definitive certificates upon exchange of the temporary global note, investors must deliver to LuxCSD the appropriate certification. The date by which the qualified investor certification must be submitted is called the “Certification Event Date”. Unless notified to the contrary by the lead manager or issuing agent, the Certification Event Date is fixed to 40 days after the closing date. Clients are notified by LuxCSD of the certification event as soon as holdings in the security are acquired. Reminders will also be sent if the duration of the certification period allows.

For clients who do not provide the appropriate qualified investor certification by the Certification Event Date or who exclude a portion of holding (securities certified as held by Non Qualified TEFRA D investors) from such certification, the uncertified or excluded portion of their holding in the relevant securities will be blocked for transfer and excluded from any entitlement.

Note: LuxCSD unblocks positions upon receipt of a certificate but reserves the right to block the same position if the certificate is rejected by the issuer or its issuing agent. The client remains fully responsible for the certificate it provides and indemnifies LuxCSD against any direct or indirect loss, claim or damage that could be incurred as a result of the unblocking followed by rejection of the certificate by the issuer or its agent.

Clients holding securities that require qualified investor certification are requested to send the appropriate certification instruction as soon as possible to LuxCSD, via the appropriate connectivity medium, before the deadline for certification. Clients are strongly recommended to provide certification via Xact Web Portal or Swift Corporate Action Instructions. LuxCSD will accept formatted Swift and Xact Web Portal instructions up to four business days after Certification Event Date. After four business days all such certification instructions will be automatically rejected, hence in such a case clients are requested to first contact LuxCSD Client Services for further assistance with providing a late certification.

If a new tranche is introduced before the certification deadline, it will effectively extend the restricted period of the TEFRA D event and a notification specifying the new certification deadline will be sent. In such a case, a previously certified position does not have to be re-instructed unless a client acquires an additional holding.

Electronic certification

Clients are allowed to certify electronically under TEFRA D rules as described in the below paragraphs. Any certifications provided via Xact Web Portal or formatted Swift message shall have the same effect of signed certificate.

LuxCSD will strictly rely on the information and statements provided by the clients and shall not be held liable for any factual errors or inconsistency contained therein. In addition, it is strongly recommended that the clients perform their own tax assessment and consult their own tax advisor regarding the certification.

For the purpose of this section, the following terms and expressions used herein shall have the following meaning:

“Non Qualified TEFRA Investor” refers to a U.S. person, that is a person that is (a) a natural person resident in the United States; or (b) a partnership or corporation organised or incorporated under the laws of the United States; (c) an estate of which any executor or administrator is a U.S. person; (d) a trust of which any trustee is a U.S. person; (e) an agency or branch of a foreign entity located in the United States; (f) a non-discretionary account or similar account (other than an estate or trust) held by a dealer or other fiduciary for the benefit or account of a U.S. person; (g) a discretionary account or similar account (other than an estate or trust) held by a dealer or other fiduciary organised, incorporated, or (if an individual) resident in the United States; and (h) a partnership or corporation if: (i) organised or incorporated under the laws of any foreign jurisdiction; and (ii) formed by a U.S. person principally for the purpose of investing in securities not registered under the Act, unless it is organised or incorporated, and owned, by accredited investors who are not natural persons, estates or trusts.

“Qualified TEFRA Investor” refers to a non U.S. person or certain person permitted under the TEFRA D rules to hold the securities in accordance with the § 165 (j) (3) of the Internal Revenue Code of 1986, as amended. “United States” means the United States of America (including the States and the District of Columbia); and its “possessions” include Puerto Rico, the U.S. Virgin Islands, Guam, American Samoa, Wake Island and the Northern Mariana Islands.

“U.S. person” refers to a legal entity or a natural person defined as a United States person in accordance with the relevant applicable laws and regulations in the United States.

Electronic certification via formatted Swift (Corporate Action Instruction)

When instructing, clients must indicate the type of beneficial owner as follows:

1. Securities certified as held by Qualified TEFRA D Investors

Clients must send to LuxCSD a formatted corporate action instruction specifying option QINV, certifying to LuxCSD that the relevant securities are owned by a Qualified TEFRA D Investor.

A securities position held by a Qualified TEFRA D Investor will not be blocked and will be authorised to receive entitlements. This holding will be exchanged from a temporary Global Note to a permanent Global Note or to definitive Certificates, as the case may be. Holders of such securities positions will be entitled to principal and interest payments.

Note: Where the entire holding is held by Qualified TEFRA D Investors, clients can alternatively certify by sending a formatted corporate action instruction with the quantity set to zero and the corporate action option code set to NOQU. LuxCSD will accept a formatted corporate action instruction with the instruction quantity set to zero for this corporate action option code only.

2. Securities certified as held by Non-Qualified TEFRA D Investors

Clients must send LuxCSD a formatted corporate action Instruction specifying the corporate action option code set to NOQU.

Clients must state that, if there are any changes in ownership between the date when certification is provided and the certification event date, that is, the last day of the Restricted Period, then an updated certification must be provided.

6.2 Income services

Income services relate mainly to the calculation of client entitlement and distribution of proceeds.

Coupons and redeemable securities are automatically presented for payment and proceeds credited to client accounts on payment date, after deduction of applicable withholding taxes and under reserve of receipt of funds by the cash correspondent banks.

Income events with options are considered by LuxCSD as corporate action events.

Income events

Income events include interest payments, dividends, capital gains and redemption payments.

Interest payments and redemption events are usually part of the official terms and conditions of the issued securities. In addition, once an issuer decides to start an income event, it will have to advise all relevant parties in the market (usually in official documentation or offer prospectus) about all aspects of the event.

Calculation methods for interest coupons

Full details of the applicable event rules are defined in the relevant prospectus of the issue. The general formula for calculating a coupon price is:

$$1000 \times \frac{\text{number of days} \times \text{interest rate}}{(360 \text{ or } 365 \text{ or } 366) \times 100} = \text{rate per 1000 (to 6 decimal places)}$$

For Floating Rate Notes (FRN),

- FRN securities issued through LuxCSD: the coupon amount calculated in this way is paid in full to clients, regardless of any rounding of the calculated amount by the paying agent.
- Investor-CSD securities: the coupon amount is paid to clients in accordance to the rounding rules announced in the local market.

As an intermediary, LuxCSD is not responsible for the calculation of Floating Rate Note (FRN) income events since issuers employ calculation agents for this purpose. However, LuxCSD will report the rates calculated by third parties for some FRN events in certain markets in order to overcome late information and, or, subsequent adjustments or reversals arising from calculation agent errors. Such rates calculated are not binding on LuxCSD.

Types of redemptions

Partially called or matured securities are automatically presented for payment. Redemption proceeds are subsequently credited on payment date, once received from our depository or agent.

Information on forthcoming redemptions (partial, early or final) can be accessed by retrieving the Income Pre-Advice Report.

Redemptions in full

Clients are notified of early redemptions as soon as the information has been received from the agent bank or published in the financial press.

In the case of early or final redemption, transactions in the respective issue can be settled up to and including the day before the redemption date.

Partial redemptions

Issues with sinking fund provisions are redeemed in part before the final redemption date, either:

- By drawing;
- By repaying for each note the appropriate percentage of principal and reducing the face value of the securities (redemption on nominal value); or
- By repaying for each note the appropriate percentage of principal without reducing the face value of the securities (pool factor).

Drawings

Drawings may occur in the case of Investor-CSD securities. All partial redemptions including drawings will be done on a pro-rata basis across client accounts. It will be the responsibility of the depositories to monitor the numbers redeemed by the issuer and mark them down accordingly.

A drawing algorithm will be applied to distribute the total amount to be drawn as equally as possible for each account participating to drawing.

Drawings processed are notified to clients. Once a drawing is announced, pre-notifications are sent to inform clients about the available drawing details such as:

- Drawing date;
- Redemption details; and
- Accrued interest, if applicable.

Once the drawing has been processed, clients will receive notification of the drawing result via Corporate Action Notification, and the result of any subsequent drawing, if applicable. On payment date, clients will receive confirmation of the debit of drawn securities via Corporate Action Confirmation. The respective cash credit is also advised to the holder of the external cash account via MT566 message type. Furthermore, information on cash movements and entitlements of partial redemptions by drawing will be included in the IPAR report.

Upon announcement of the drawing, the securities are blocked for cross-CSD deliveries on record date of the drawing. Undrawn bonds are available for settlement immediately after processing of the respective blocking instructions.

For a **total** redemption (whether early or final), transactions in the redeemed issue can be settled up to and including the day before redemption date, **whereas** positions drawn in a **partial** redemption are blocked immediately and therefore cannot be used for settling trades. Although no longer available for delivery, the blocked securities still form a part of the client's securities holdings until payment for them has been received.

While these redemption payments are usually made on an interest payment date, the payment will be made separating the interest from the redemption amount of the drawn bonds.

In the exceptional case that the drawing event must be processed on a business day within the interest period, the accrued interest and the redemption amount of the drawn bonds are credited in a single payment. The payment confirmation generated details the interest and redemption amount split.

Redemption on nominal value

In the case of redemption on nominal value, an equal part of all notes of a security is redeemed and the denominations are reduced accordingly.

Amounts to be redeemed are notified to clients as soon as the information is received from the agent bank or published in the financial press.

While these repayments are usually made on an interest payment date, the interest and redemption amounts are paid separately.

Partial redemption with a pool factor

In the case of a partial redemption with a pool factor, an equal part of all notes of a security is redeemed but the denominations are not reduced accordingly. A ratio (the “pool factor”) is assigned to the security and reflects the face value of principal having still to be redeemed. For each interest payment, the amount of interest payable is then calculated on the basis of the outstanding amount of principal and not on the basis of the denomination of the security.

Amounts to redeem are notified to the clients as soon as the information is received from the agent bank or published in the financial press.

While these repayments are usually made on an interest payment date, the interest and redemption amounts are paid separately. The principal, together with details of the pool factor and interest, are reported separately by IPAR.

Note: The pool factor method is sometimes also used for securities that are capitalising interest. In this case, the ratio is increased by the amount of interest that is capitalised.

Income key dates

Figure 6-1 shows the timeline of the key dates for an income payment.

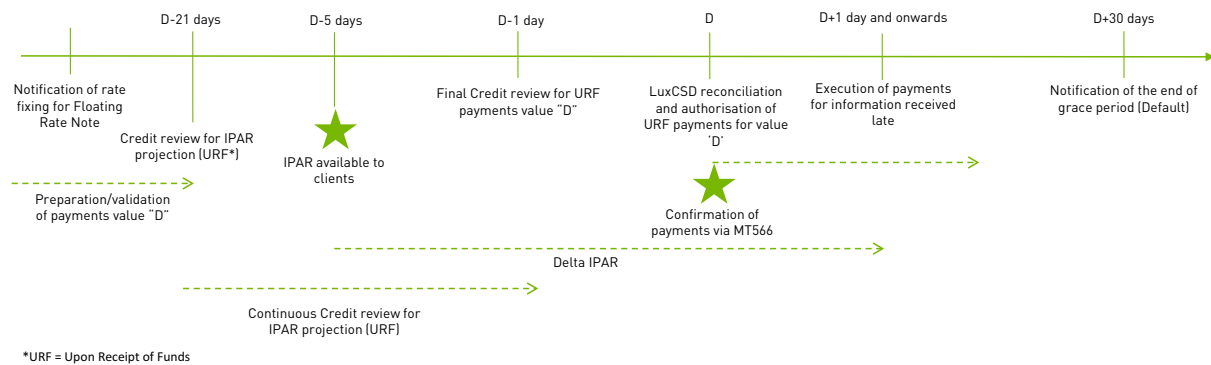

Figure 6-1. Typical timeline of event setup and processing

Record date

The record date is the date on which LuxCSD establishes which holders are recorded in the system as eligible to receive the coupon, or other entitlement, on a security.

For securities issued through LuxCSD, the record date is usually the close of business, one business day before the payment date of the coupon (or other entitlement). For securities held on CSD links, the record date varies for different security types according to market practice, as detailed in the respective Market Guide.

For technical or administrative reasons, and in order to ensure best possible value to the income payment, external depositories may be required to detach coupons earlier than the official record date, especially in the case of physical detachments. Physical deliveries requested close to coupon record date may therefore be effected ex-coupon.

As a general rule, entitlement to income distribution is calculated on the record date of the relevant payment. For account holdings that qualify for income distribution, this is determined after the end of day processing. However, clients should note that information may be received from depositories after the deadline for inclusion in the end of day processing, resulting in later adjustment to entitlement positions.

6.3 Corporate action services

A corporate action is any event that impacts the rights of a company's shareholders or bondholders, excluding income events like interest or dividend payments.

It may be initiated by the issuer or a third party or by an action of holders. For some corporate action events, the securities holders must respond by selecting from a list of possible actions.

LuxCSD informs clients about all upcoming corporate actions applicable to securities held on their account, where information about the event has been provided by an authorised and authenticated party and where the initiator of the event is recognised as authorised to do so. This excludes non official offers and/or offers handled outside the clearing system.

LuxCSD sends individual notifications, via the connectivity channels, for each holding in the security.

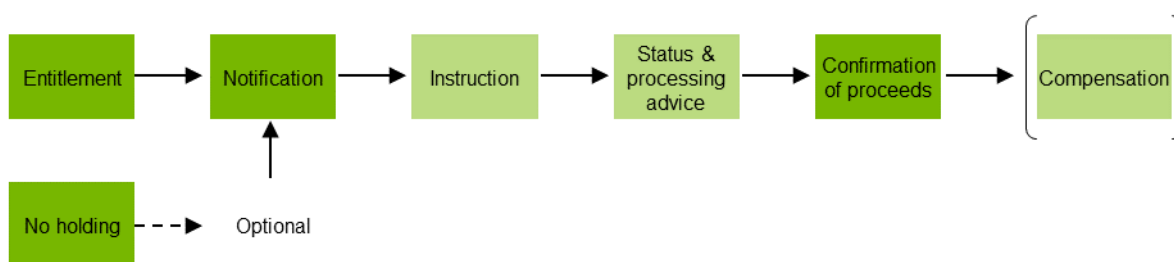

Figure 6-2. Corporate action event life cycle

Clients are requested to verify, in advance, their account setup eligibility to receive underlying proceeds for a corporate action event. Their account profile and the actual beneficial owner need to comply with any restrictions that apply to these proceeds.

If account setup restrictions do not permit the crediting of underlying proceeds (for example, due to tax or market restrictions), delivery details outside LuxCSD must systematically be included on the respective instruction.

Corporate action events

Corporate actions can be divided into two broad categories of event:

- **Predictable events**

Events foreseen in the security's documentation, for example the terms and conditions, including wording around the event timing and deadlines. Securities documentation is collected and made available to clients through Xact Web Portal.

Examples of predictable events are: conversion option, put option, warrant exercise.

- **Unpredictable events**

Events not foreseen in the security's documentation, for example terms and conditions. They are announced and described in additional documents by the issuing company's management.

Examples of unpredictable events are: purchase offer, stock split.

Both predictable and unpredictable events can be subdivided into three main categories based on whether the holder of the securities has to take action on the event or not:

- **Mandatory events**

Participation and consequences are compulsory and apply to the whole outstanding amount held within LuxCSD. No instruction from the security holder is required.

Examples of mandatory events are: stock split, rights distribution, merger.

- **Mandatory events with choice**

Participation and consequences are compulsory and apply to the whole outstanding amount held within LuxCSD; however a choice or option is available to the security holder. An instruction is only required if the security holder does not want the default option to be applied.

Examples of mandatory events with choice are: merger with choice, bonus non-automatic.

- **Voluntary events**

Participation and consequences are at the holder's discretion. An instruction is required if the security holder wishes to participate. The issuer will usually inform all holders of the event that is about to take place; sometimes this notice is provided in the original offering documentation for the security. If the holder take no action then the default action as stated in the notification will be applied.

Examples of voluntary events are: purchase offer, conversion option, subscription offer.

Some complex corporate actions may involve mandatory events with subsequent voluntary events (two-leg events); for example, a mandatory rights distribution followed by a subsequent voluntary subscription offer.

LuxCSD supports all types of corporate actions events defined by the CASG standards:

- **Cash distributions:**

Cash distribution is a distribution where the proceeds consist of cash only (for example, cash dividend, interest payment)

Three key dates are used for mandatory cash distributions:

- the ex-date;
- the record date;
- the payment date.

- **Securities distributions:**

Securities distribution is a distribution where the proceeds consist of securities only (for example stock dividend, bonus issue).

The key dates and the order of dates used for securities distributions are the same as for cash distributions.

- **Distributions with options:**

As a general rule, the distribution with options is handled via two events:

- a distribution of intermediary securities (refer to securities distribution above) followed by
- a mandatory reorganisation with options (refer to mandatory reorganisations below) (for example optional dividend).

The key dates and the order of dates are the same as for cash distributions for the first event and the same as mandatory reorganisation with options for the second event.

- **Mandatory reorganisations**

A mandatory reorganisation is a reorganisation that mandatorily affects the underlying security (for example stock split, redemption).

Three dates are used for mandatory reorganisation:

- the last trading date;
- the Record Date;
- the payment date.

- **Mandatory reorganisations with options**

A mandatory reorganisation with options is a mandatory reorganisation with a choice of proceeds (for example, merger with election).

The following dates are used for reorganisations with options:

- start of election period;
- end of election period;
- guaranteed participation date;
- buyer protection deadline;
- response deadline;
- market deadline;
- payment date.

- **Voluntary reorganisations**

A voluntary reorganisation is a reorganisation in which participation is optional for the holder of the underlying security (for example, tender offer).

The key dates and the order of dates used for voluntary reorganisations are the same as for mandatory reorganisation with options.

Corporate action events on existing securities that involve the creation of a new security (new ISIN) cannot be processed without a valid LEI. For further information about creation of new securities, please refer to [Chapter 5. New Issues](#).

Corporate action instructions

Clients may instruct on voluntary and mandatory with choice events using the following media:

- Xact Web Portal;
- Xact File Transfer;
- Swift message by using the BIC address: CEDELULL or LUXCLULL.

Instructions received from clients are validated and forwarded to the depository or the agent either one by one or bulked on deadline date. If a corporate action instruction does not include an execution date, the instruction will be considered as if received for processing on the next possible execution date.

The service will differentiate between following instructions statuses:

- Correctly formatted instructions will benefit from a more competitive LuxCSD deadline.
- Free format messages and unsolicited instructions will have a standard deadline and will be subject to an additional fee.
- Incorrectly formatted instructions will have a standard deadline.

Note: Incorrectly formatted instructions increase the risk of rejection.

In order to encourage the correct formatting of corporate action instructions the pricing model will apply an additional fee to free format messages, unsolicited instructions and manual repairs.

- Unsolicited instructions (Swift, Xact Web Portal or Xact File Transfer via Internet CSV file upload) where the Corporate Action Reference ID is missing and for which the client has received this Corporate Action Reference ID previously in the related MT564 Corporate Action Notification before sending the instruction.
- Any client instruction received via Swift, Xact Web Portal or Xact File Transfer via Internet CSV file upload where the required information has been incorrectly populated through dedicated structured fields.
 - Instructions where the Beneficiary details are required and are not included in the dedicated structured fields from BENODET sequence will be manually repaired and subject to an additional fee.
 - Instructions for Dutch Auction events, where the Bid Price for the competitive option is provided, will be manually repaired on a best effort basis and subject to an additional fee in the following instances: the bid price is not included in the structured field 90a::OFFR// or is not correctly formatted.

Incorrectly formatted instructions provided via Swift or Xact Web Portal that are automatically rejected will immediately trigger a Swift Corporate Action Status and Processing Advice indicating the reason for rejection.

In order to further improve STP processing and to provide LuxCSD deadlines closer to market deadlines, LuxCSD will:

- Ignore certain narrative types in the Corporate Action Instruction, as indicated:
 - When present in the Instruction block (CAINST):
 - COMP: Information to be complied with;
 - FXIN: Forex Instructions Narrative;
 - When present in the Additional Information block (ADDINFO):
 - PACO: Party narrative.
- Ignore any narrative type for specific corporate events unless the event specifically requires the use of a narrative. Clients will be informed that the rule is applicable for a given event through the relevant MT564 Corporate Action Notification. A fixed standard text will be added in the notification (Additional Text (ADTX) in the Corporate Action Options block (CAOPTN)). This text will specify that any narrative received in the client instruction on the related option will be disregarded.

For all events (if applicable) the standard deadline for free format messages, unsolicited instructions and incorrectly formatted instructions will be provided in the Corporate Action Notification.

If there is no deadline in the Corporate Action Notification, for example as in Equity Linked Notes, the fixing date is considered as the relevant LuxCSD deadline.

Note: LuxCSD will not be held liable for not taking any action on any Instruction that is not sent via the proper channels (Swift, Xact Web Portal or Xact File Transfer CSV file upload) unless unavailable.

Instruction format

To ensure fast processing and to benefit from the full life cycle of information, clients should send corporate action instructions using an available connectivity method:

- Standard rules for the completion of the formatted Swift Corporate Action Instruction or Xact Web Portal, as described in the Swift User Guide or Xact Web Portal User Manual, must be followed.

- Any additional information required as described in the corporate action notification must be included.

If instructions are sent as free format message, automatic validation and processing is not applicable. Free-format instructions can be accepted, respecting the following data as mandatory to ensure validity:

- Exact event type;
- Corporate Action Reference ID and/or event name;
- Client account number;
- Nominal quantity;
- The financial instrument identification number (ISIN or Common Code);
- The selected option (note that “No Action - NOAC” instructions are considered as an option);
- Any additional information required as described in the corporate action notification.

For risk management reasons, corporate action instructions by fax or email are not accepted. Clients operating in contingency mode may be allowed to instruct via fax or email provided they duly execute a letter of indemnity in favour of LuxCSD.

Clients must only include one instruction per message. One instruction consists of: one financial instrument identification number (ISIN or Common Code), one account number, one nominal, one option (No Action - NOAC instructions being considered as an option). If a client includes more than one instruction per message, or if the additional text field on formatted messages includes an instruction or contradicts with the instruction given in the structured fields, LuxCSD cannot be held responsible for any loss or damage caused. LuxCSD reserves the right to reject instructions not formatted as per recommendations.

CSV file upload

Clients can upload a CSV file with up to 100 Instructions via Xact Web Portal.

To cater for higher volumes, clients can upload a CSV file with up to 10,000 Instructions via Xact File Transfer via Internet.

For risk management reasons, to upload a CSV file with more than 100 Instructions, clients must communicate to Client Services their intention to use this functionality at least 24 hours before the relevant LuxCSD deadline (this is the earliest deadline if there are events with multiple deadlines), providing following data:

- Corporate action reference ID;
- Number of Instructions to be uploaded.

Upload via Xact File Transfer via Internet with more than 100 instructions must be completed at least three hours before the relevant LuxCSD deadline (this is the earliest deadline if there are events with multiple deadlines).

Failure to comply with above requirements will result in LuxCSD handling the instructions on a “best efforts” basis and execution cannot be guaranteed.

Instruction collection

Solicited events fall under a predefined exercise period punctuated by a deadline, as reported on the corporate action notification. Clients should always send instructions prior to the LuxCSD deadline. Instructions are processed according to deadline priorities.

Unsolicited events fall under an open exercise period, and can be instructed anytime. As a standard rule, valid client instructions are processed on a continuous basis throughout the day.

Holdings will be blocked, unblocked or debited for delivery, if appropriate, based on the instruction and the corporate action type and terms when a valid instruction is received from the client. For a corporate action instruction received before an exercise period, there will be no preliminary blocking of securities.

Late instructions

Instructions received after the deadline are handled on a best efforts basis and are transmitted to the external market/agents, however, execution cannot be guaranteed. If the instruction received after the deadline cannot be executed, a default action will be applied as stated in the notification (default indicator).

When an instruction comes in after deadline clients receive an acknowledgement (MT567), advising the client that the instruction is after deadline and will be processed on a best efforts basis. After feedback from the external market/agent a revised processing advice is sent to clients.

Formatted client instructions received during suspension periods or before exercise periods will be automatically rejected. However, if the suspension period end date or the exercise period start date is within five business days of receipt of the instruction, the instruction will be held in suspense until such dates are reached.

LuxCSD cannot be held liable for the non-execution of late, incorrect or incomplete instructions.

No action instruction

“No action” instructions are considered and recorded with the same priority equal to all other instructions. As a result, positions instructed for “no action” will not be eligible to participate in the respective event unless the instruction is cancelled and replaced.

Cancellation of previous instructions by clients

If instructions have already been processed and forwarded to the external market or the agent, LuxCSD will forward the cancellation request accordingly, but cannot guarantee execution of the cancellation request.

To replace a sent instruction, clients must send a cancellation message before the new instruction.

Clients are requested to cancel formatted instructions with a formatted cancellation only (Swift and Xact Web Portal).

LuxCSD cannot be held responsible for any loss or damage caused by a client's failure to comply with the cancellation and replacement procedure.

Missing instructions

The Urgent Uninstructed Balances report, available through Xact File Transfer, gives an overview of uninstructed balances for corporate actions and assists clients in monitoring risk relating to voluntary corporate actions. If no instruction is sent, the default action will be applied as stated in the notification (default indicator).

Completion of paper forms on behalf of clients

LuxCSD includes, as part of its standard custody service, the completion of paper forms to participate in a corporate action provided this is permitted under the terms and conditions of the issue and/or by the issuer or its agent.

However, for events where it is a requirement that the form be completed and signed by the actual legal or beneficial holder, or where the issuer and/or their agent explicitly state that the clearing systems cannot complete the form on behalf of the participating holder, we provide clients with the necessary forms, or with information on how to obtain them, in order to participate in the event.

Status and processing advice

Clients will receive a status and processing advice message for each corporate action instruction sent.

If the corporate action instruction was sent using a free-format message, clients will not receive a status and processing advice and are responsible for monitoring the instruction execution.

Clients using Xact Web Portal can check the status of their corporate action instructions directly in Xact Web Portal and schedule the receipt of an MT567 via Swift.

In order to receive acknowledgements via Swift, a valid Swift address is required and the check boxes for "Acknowledgement of messages" and "Include all media channels" must be checked in the Scheduled Reports details.

Rejection of instructions

If the securities provision is not sufficient, instructions will not be executed, but held in suspense either for a period of five consecutive business days starting on the date of receipt of the instruction or until the relevant deadline, whichever occurs first.

The account holder will be informed of the non-execution and rejection of corporate action instructions in the following cases:

1. The instruction is incomplete or invalid (as per, without limitation, instruction format definition).
2. Cash provision is insufficient for the execution of the instruction.
3. The required certification or document is not provided together with the related instruction.
4. The specified place of safekeeping in the related Instruction does not correspond to the depository defined in the event referred by the corporate action reference ID (received in the related Corporate Action Notification).
5. The corporate action reference ID is missing and the CAEV, ISIN (or common code) and place of safekeeping (:94F::SAFE) provided in the related Instruction do not match with an event.
6. Any additional requirements are not satisfied (for example if the proceeds security is not eligible in LuxCSD or in Clearstream; if the appropriate delivery instruction outside of the Creation system is not provided with the instruction).

LuxCSD cannot be held responsible for any loss or damage caused by a delay in the execution of an instruction or cancellation of an instruction that did not fulfil one or more of the above conditions.

Fractions handling

Whole shares resulting from corporate actions will be credited to client accounts and any remaining fractional units will be rounded down to the next whole number of shares and the cash equivalent will be credited to the client's DCA account¹. The cash equivalent will be either the market value as determined by the depository or LPA or the up-to-date market value at which the securities are traded on the exchange. This rule only applies if there is any market for fractions and may be affected by market trend and/or trading value, which can lead to the cancellation of fractions. Clients are informed of the relevant details on the booking advice.

Fractions Handling for DE-securities is done by creating a separate interim line, a temporary ISIN, credited to entitled clients.

When a Corporate Action event (for example, a SPLIT EVENT) where a securities ratio results in fractions, the event is processed in two steps:

Step 1: A mandatory event to credit an interim ISIN with fractions;

Step 2: A mandatory event with choice to credit the new ISIN, with the following options:

Option a: Securities where the interim ISIN is converted into the final ISIN with a one-to-one ratio.

Note: This can only be done using the Multiple Settlement Amount of the new ISIN, without any remaining fractions.

1. For non-T2S eligible securities issued through LuxCSD, the client's pre-assigned ICSD-linked account is credited.

Option b: Cash where fractional positions can be fully converted.
The default option is Option a (securities proceeds).

6.4 Event notifications and entitlement forecast

Event information

Information sources

Event information is received and compared from different sources such as the terms and conditions of the issue, the LuxCSD Principal Agent (LPA), depositories, issuer agents, agents, financial publications as well as independent information vendors. Corporate action¹ notifications are prepared based on this information and transmitted to clients as soon as possible, generally within 24 hours after market announcement date.

The depository, issuer or issuing agent (for Investor-CSD custody services) and the LPA (for custody services for securities issued through LuxCSD) are the prime source of confirmed information for corporate actions. Notifications are released when confirmed information is available. Information vendor's information is considered as "unconfirmed" and may be used for corporate action event setup and pre-notifications to clients. At discretion, it is decided whether and when unconfirmed information is to be forwarded to clients and such information is flagged as "unconfirmed" if provided.

Terms and conditions

Details of events are summarised via corporate action notifications. This summary will not constitute a legally binding description of the choices offered to clients and cannot be relied upon as such. Clients are considered to fully understand the terms of the corporate action and to instruct accordingly. Clients may wish to seek independent legal and tax advice on the terms of the corporate action and its impact on their specific situation before instructing LuxCSD.

Clients are provided with relevant publications by offering material or restrictions via the Corporate Action database, if and when they are available. Availability is advised through the corporate action event notification. Clients can place an email request to receive terms and conditions related to the event to CAdatabase.CS@luxcsd.com (as per the terms of the related notification).

No part of the requested documents neither the information contained therein can be reproduced or transmitted in any form or by any means, electronic or mechanical, if neither the client nor the addressee is entitled to participate in the relevant corporate action. Clients are aware that they shall bear sole responsibility for any and all harmful consequences, losses or damages, which may be suffered for any reason whatsoever by clients, the addressee, third parties or LuxCSD by reproducing or transmitting the requested documents or the information contained therein.

Disclosure

In accordance with market laws, investors may be required to disclose their relevant interest in securities. LuxCSD may be requested to comply with certain disclosure requirements². Clients are informed of these disclosure requests by a specific notification. The notification will also advise clients whether they are required to send an instruction or not.

For dematerialised securities eligible in LuxCSD, issuers may request LuxCSD to comply with certain disclosure requirements, in accordance with Article 17 of the law of 6 April 2013 on dematerialised securities. If requested information is not, or is only partially, disclosed within two months of the initial request, issuers may suspend the voting rights of the relevant securities until full disclosure.

Clients are advised to seek legal guidance on the existence and scope of any potential disclosure requirements applicable to such clients and relating to their holdings. LuxCSD is not responsible for advising clients on the validity and extent of disclosure requests.

1. In this section corporate action refers to both income and corporate action events.

2. Disclosure requirements are published by market on the LuxCSD website under Products & Services / Market Coverage.

Choice dividend on the German market

A choice dividend event on German domestic securities gives shareholders the possibility to choose between three options:

1. Receive full cash from the tax free dividend (default option):

If there is a taxable dividend payment based on the parent line, it will be paid via cash dividend event;

2. Receive a tax free dividend in form of additional shares:

A Rights distribution event will be used to credit the CASH interim line. A choice dividend event will be triggered from the CASH interim line and will offer the possibility to opt for the SECU option for a SECU interim line. A mandatory Exchange offer event will be triggered from the SECU interim line to receive the final security;

3. Receive a tax free dividend as a combination of cash and additional shares.

Shareholder identification under the Shareholder Rights Directive II (SRD II)

The Shareholder Rights Directive provides the right to issuers for identification of their shareholders. Issuers (or their nominated third-party provider) can request intermediaries at each level of the custody chain to provide relevant information to facilitate such identification.

In line with Market Standards for Shareholder Identification and the SRD II requirements, LuxCSD will, upon receipt of the shareholder identification request, validate (when acting as first intermediary) and transmit this request without delay to the next intermediaries in the custody chain. A response to the shareholder identification request shall be sent by every intermediary in the custody chain without delay directly to the response recipient's address defined in the request. LuxCSD, in its role as intermediary, will also generate a response to the recipient with information regarding the shareholder's identity, limited to LuxCSD books only.

For markets subject to SRD II, please refer to the Disclosure Requirements for the relevant market on the LuxCSD website. Clients are strongly recommended to seek legal guidance on the existence and scope of SRD II requirements (for example, threshold, eligible assets) applicable to these clients and related to their holdings.

Dissenter's rights

In accordance with applicable laws, investors may be allowed the right to receive a cash payment for the fair value of their securities, in the event of a corporate action to which the investors do not consent.

Clients are informed of this right by a specific indicator in the notification (DISS - Dissenter's rights).

For risk management reasons clients must communicate to Client Services their intention to make use of the dissenter's right feature immediately upon receipt of the relevant event notification and will be given all the pertinent information to perform their request to the company.

LuxCSD cannot be held responsible for any legal cost and fees incurred by dissenter investors pursuing this action.

Fees

In accordance with domestic laws, investors may be required to pay certain fees, if appropriate, based on the corporate action type and terms. Clients are informed of these fees, if applicable, in the relevant notification.

Event reporting

The below mentioned reports will be sent to clients to provide an account owner with the details of an event along with the possible elections or choices available:

Report purpose	Message Type		Description
	ISO 15022	ISO 20022	
New Message Notification	MT564 NEWM	Seev.031 (CANO)	New notification.
Replacement Notification	MT564 REPL	Seev.031 (CANO)	Supplementary information is provided.
Reminder Notification	MT564 RMDR	Seev.031 (CANO)	Reminder to client that CBL has not received their instruction.
Income Pre-Advice Report	MT564 REPE (IPAR)	Seev.035 (CAFE)	Eligible balance notification, reporting an eligible balance that may or may not include an entitlement calculation or a revised entitlement calculation.
Claim and Reversal Advice	MT564 ADDB (CRA)	Seev.044 (CAPC)	Notification of a market claim or reverse market claim subject to compensation by CBL that has been detected.
	MT564 CANC (CRA)	Seev.044 (CAPC)	Notification of a cancellation of a reported market claim or reverse market claim.
	MT564 ADDB REVR (CRA)	Seev.044 (CAPC)	Reversal advice of an income or non-income event. Reversal advice of a compensated market claim or reverse market claim.
Cancellation Notification	MT564 CANC	Seev.039 (CANC)	Cancellation advice of an event previously announced by CBL.
Withdrawal Notification	MT564 WITH	Seev.039 (CANC)	Withdrawal of the event or offer by the issuer (all previously sent event information is void).
Formatted Corporate Action Instruction	MT565		
Corporate Action Confirmation	MT566		

An official corporate action reference (COAF) will be shown if allocated and reported by the Issuer CSDs.

LuxCSD endeavours to check the information with multiple sources with the objective to send notifications in a timely manner with status “confirmed” and “complete”. In some cases, the terms of a corporate action or processing details may not be available until late in the life cycle.

“Incomplete” notifications may be sent in order to provide clients with the available information.

In Xact Web Portal, a specific flag facilitates the identification of events where instructions are requested: “For Your Information” (FYI) notification will be sent for the mandatory events where no action from the client is necessary. Voluntary events will be created as “Your Instruction Requested” (YIR). The events concerned are those requiring a decision or action from the holder of the securities.

Whenever the event is cancelled or withdrawn, it will be reported via the appropriate message (MT564 CANC/WITH).

LuxCSD informs clients about upcoming mandatory and voluntary corporate actions applying to securities held on their account as soon as possible and only after being notified of an event. The

entitled holding is fixed on record date or on actual date, according to the terms and conditions of the relevant corporate action.

Notifications for the relevant securities holdings are released on a continuous basis during the day.

Reminder notifications will be sent to clients automatically for any uninstructed position.

LuxCSD sends the Reminder Notification messages (MT564 RMDR) "Your Instruction Required - Reminder" where the eligible position is either not instructed at all or partially not instructed. This message includes two additional balances, which are:

- INBA: Instructed Balance;
- UNBA: Uninstructed Balance.

Whenever applicable to the corporate action, the fraction handling details will be reported in standard fields.

Clients without a holding in a particular security can access the corporate action information, either using a query in Xact Web Portal or by subscribing to the dedicated "Corporate Actions Notifications without Holdings Report" in Xact File Transfer or Xact Web Portal.

The Claim and Reversal Advice (MT564 ADDB REVR) notifies clients of an upcoming reversal on one of the following paid income or non-income events:

Equities

- ACCU: Accumulation
- BONU: Bonus Automatic
- CAPD: Capital Distribution
- CAPG: Capital Gain Distribution
- DECR: Decrease in Value (share)
- DRCA: Cash Distribution from Non-Eligible Securities
- DVCA: Dividend (including with a currency option)
- DVSE: Stock Dividend
- LIQU: Liquidation (without debit of basis security)
- RHDI: Rights Distribution
- SHPR: Shares Premium Dividend
- SOFF: Demerger/Spin Off
- SPLF: Stock Split
- SPLR: Reverse Stock Split

Debt

- DRAW: Drawing
- EXOF: Mandatory Exchange Offer
- INTR: Floating Coupon
- INTR: Fixed Coupon
- LIQU: Liquidation (without debit of basis security)
- MCAL: Early Redemption
- MRGR: Merger
- PARI: Pari-Passu
- PCAL: Partial Redemption (only applicable to drawings on Danish debt instruments)
- PINK: Payment in kind

- PRED: Partial Redemption without Reduction of Nominal Value
- REDM: Final Redemption
- REDM: Redemption in Shares at the Issuer's Option
- TEND: Mandatory Tender Offer/Purchase offer

Entitlement forecast

The Income Pre-Advice Report (IPAR - MT564 REPE) enables clients to retrieve available information on future proceeds (cash and securities) and capital repayments for all securities held in their accounts, for each place of safekeeping. The report covers the payments that are expected in the five Business Days following the report on a rolling basis. Proceeds which have not been executed on the scheduled payment date will be reported on IPAR for the next 30 calendar days after the scheduled payment date. After this period, clients will be notified of any event of non-payment or default and further follow-up processing will be performed by the corporate actions team.

For securities eligible in T2S, the IPAR can only be subscribed to or retrieved via the safekeeping account in both cash and securities proceeds. Reports can be retrieved selectively by currency, date, event type or security code.

For securities non-eligible in T2S, the IPAR can be subscribed to or retrieved via the external cash account for income proceeds with CBL assigned in the Account Application Form or via the safekeeping account in CBL for securities proceeds.

The IPAR is accessible through:

- Swift (Corporate Action Notification), the standard use of which can be replaced by, MT568 (Corporate Action Narrative) in exceptional cases,
- Xact Web Portal, for operations related to securities,
- Xact File Transfer (in XML, XLS and PDF format).

In the IPAR, securities balances are updated four times a day: at 03:00, 08:00, 21:30 and 22:30. Entitled balances (on record date) are fixed after the end of day processing that reflects the end of day balances.

In addition to settled and eligible balances, IPAR shows a more complete set of balances, such as:

- AFFB: Affected Balance;
- UNAF: Unaffected Balance;
- PEND/ELIG: Pending Delivery Eligible Balance;
- PEND/NELG: Pending Delivery Not Eligible Balance;
- PEND: Pending Delivery Balance;
- PENR/ELIG: Pending Receipt Eligible Balance;
- PENR/NELG: Pending Receipt Not Eligible Balance;
- PENR: Pending Receipt Balance;
- COLI: Collateral In Balance
- COLO: Collateral Out Balance
- INBA: Instructed Balance (applicable only for events requiring instruction);
- UNBA: Uninstructed Balance (applicable only for events requiring instruction).

The IPAR (MT564 REPE with ADDB//CAPA) gives the following details:

- Breakdown of the cash and/or securities payment that will be done for the account.
- Tax related information, including net calculated entitlement
- Any debit movement of security

- Settlement position and eligible quantity
- Pending receivable cash amount/securities based on entitlement

In addition, intraday IPARs will be generated if important details about a payment (such as the rate of interest or the Record Date) have been updated for the related Value Date. These additional intraday IPARs will only include the updates to existing proceeds and new proceeds created on Value date -1. They will not be created for updates to Balances arising from any intraday Settlement activities.

IPAR is available in two forms:

- The complete report, which covers all cash and securities proceeds that are expected to be payable to the account for each place of safekeeping during the succeeding five Business Days; and
- The delta report, which covers only those proceeds that are new and/or changed since the last report that was retrieved, thereby allowing easier identification of new items and reducing reporting costs.

For both types of IPAR, clients have the choice of whether or not to include pending transactions. This feature is not available to income on equities although the total quantities of pending receivables or deliverables are shown on the report.

The IPAR is not a confirmation of receipt of proceeds, but rather a projection of cash or securities to be expected which is subject to LuxCSD's conditions for income and redemption payments. Therefore, LuxCSD provides the IPAR for information purposes only. LuxCSD does not warrant the accuracy and completeness of the IPAR and shall not be liable for any action taken based on this report.

All payments are flagged as payable "Upon Receipt of Funds" (URF).

List of events

The following table is a non-exhaustive list of the corporate action events that are currently handled.

Each description is a brief definition used internally, and as such may not reflect all characteristics of the event as it may be defined by the securities industry.

CAEV	Event	Description
ACCU	Accumulation	Funds related event in which the income (for example accumulation units) that accrues during an accounting period is retained within the fund instead of being paid away to investors. The retained income is nonetheless deemed to have been distributed to investors for tax purposes.
ACTV	Trading Status: Active	Trading in the security has commenced or security has been re-activated after a suspension in trading.
ATTI	Attachment	Combination of different security types to create a unit. Units are usually comprised of warrants and bonds or warrants and equities. Securities may be combined at the request of the security holder or based on market convention.
BIDS	Repurchase Offer/Issuer Bid/Reverse Rights	Offer to existing holders by the issuing company to repurchase its own securities. The objective of the offer is to reduce the number of outstanding securities.
BMET	Bond Holder Meeting	Physical meeting of bond holders.
BONU	Bonus Issue/Capitalisation Issue	Bonus, scrip or capitalisation issue. Security holders receive additional assets free of payment from the issuer, in proportion to their holding.

CAEV	Event	Description
BPUT	Put Redemption	Early redemption of a security at the election of the holder subject to the terms and condition of the issue with no reduction in nominal value.
BRUP	Bankruptcy	Legal status of a company unable to pay creditors. Bankruptcy usually involves a formal court ruling. Securities may become valueless.
CAPD	Capital Distribution	The Corporate event pays shareholders an amount in cash issued from the Capital account. There is no reduction to the face value of a single share (or the share has no par value). The number of circulating shares remains unchanged.
CAPG	Capital Gains Distribution	Distribution of profits resulting from the sale of company assets, for example, Shareholders of Mutual Funds, Unit Trusts, or Sicavs are recipients of capital gains distributions which are often reinvested in additional shares of the fund.
CAPI	Capitalisation	Increase of the current principal of a debt instrument without increasing the nominal value. It normally arises from the incorporation of due but unpaid interest into the principal. This is commonly done by increasing the pool factor value, for example, capitalisation, and negative amortisation.
CERT	Non-US TEFRA D Certification	Non-US beneficial owner certification requirement for exchange of temporary to permanent notes.
CHAN	Change	Information regarding a change further described in the corporate action details.
CMET	Court Meeting	Announcement of a meeting at a Court.
CONS	Consent	Procedure that aims to obtain consent of holder to a proposal by the issuer or a third party without convening a meeting. For example, consent to change the terms of a bond.
CONV	Conversion	Conversion of securities (generally convertible bonds or preferred shares) into another form of securities (usually common shares) at a pre-stated price/ratio.
CREV	Credit Event	An occurrence of credit derivative for which the issuer of one or several underlying securities is unable to fulfil his financial obligations (as defined in terms and conditions).
DECR	Decrease in Value	Reduction of face value of a single share or the value of fund as-sets. The number of circulating shares/units remains unchanged. This event may include a cash payout to holders.
DETI	Detachment	Separation of components that comprise a security, for example, usually units comprised of warrants and bond or warrants and equity. Units may be broken up at the request of the security holder or based on market convention.
DFLT	Bond Default	Failure by the company to perform obligations defined as default events under the bond agreement and that have not been remedied.
DLST	Trading Status: Delisted	Security is no longer able to comply with the listing requirements of a stock exchange and is removed from official board quotation.

CAEV	Event	Description
DRAW	Drawing	Redemption in part before the scheduled final maturity date of a security. Drawing is distinct from partial call since drawn bonds are chosen by lottery and with no reduction in nominal value.
DRCA	Cash Distribution From Non-Eligible Securities Sales	Distribution to shareholders of cash resulting from the selling of non-eligible securities, for example, in the frame of a depositary receipt program.
DRIP	Dividend Reinvestment	Dividend payment where holders can keep cash or have the cash reinvested in the market by the issuer into additional shares in the issuing company. To be distinguished from DVOP as the company invests the dividend in the market rather than creating new share capital in exchange for the dividend.
DSCL	Disclosure	Requirement for holders or beneficial owners to disclose their name, location and holdings of any issue to the issuer.
DTCH	Dutch Auction	An action by a party wishing to acquire a security. Holders of the security are invited to make an offer to sell, within a specific price range. The acquiring party will buy from the holder with lowest offer.
DVCA	Cash Dividend	Distribution of cash to shareholders, in proportion to their equity holding. Ordinary dividends are recurring and regular. Shareholder must take cash and may be offered a choice of currency.
DVOP	Dividend Option	Distribution of a dividend to shareholders with a choice of benefit to receive. Shareholders may choose to receive shares or cash. To be distinguished from DRIP as the company creates new share capital in exchange for the dividend rather than investing the dividend in the market.
DVSC	Scrip Dividend/Payment	Dividend or interest paid in the form of scrip.
DVSE	Stock Dividend	Dividend paid to shareholders in the form of equities of the issuing corporation.
EXOF	Exchange	Exchange of holdings for other securities and/or cash. The exchange can be either mandatory or voluntary involving the exchange of outstanding securities for different securities and/or cash. For example "exchange offer", "capital reorganisation" or "funds separation".
EXRI	Call on Intermediate Securities	Call or exercise on nil paid securities or intermediate securities resulting from an intermediate securities distribution (RHDI). This code is used for the second event, when an intermediate securities' issue (rights/coupons) is composed of two events, the first event being the distribution of intermediate securities.
EXTM	Maturity Extension	As stipulated in a bond's Terms and Conditions, the issuer or the bond-holder may prolong the maturity date of a bond. After extension, the security may differ from original issue (new rate or maturity date). May be subject to bondholder's approval.

CAEV	Event	Description
EXWA	Warrant Exercise	Option offered to holders to buy (call warrant) or to sell (put warrant) a specific amount of stock, cash, or commodity, at a predetermined price, during a predetermined period of time (which usually corresponds to the life of the issue).
INCR	Increase in Value	Increase in the face value of a single security. The number of circulating securities remains unchanged.
INFO	Information	Information provided by the issuer having no accounting/financial impact on the holder.
INTR	Interest Payment	Interest payment distributed to holders of an interest bearing asset.
LIQU	Liquidation Dividend/Liquidation Payment	A distribution of cash, assets or both. Debt may be paid in order of priority based on preferred claims to assets specified by the security.
MCAL	Full Call/Early Redemption	The redemption of an entire issue outstanding of securities, for example, bonds, preferred equity, funds, by the issuer or its agent, for example, asset manager, before final maturity.
MEET	Annual General Meeting	Annual general meeting.
MRGR	Merger	Exchange of outstanding securities, initiated by the issuer which may include options, as the result of two or more companies combining assets, that is, an external, third party company. Cash payments may accompany share exchange.
ODLT	Odd Lot Sale/Purchase	Sale or purchase of odd-lots to/from the issuing company, initiated either by the holder of the security or through an offer made by the issuer.
OTHR	Other Event	Other event, use only when no other event type applies, for example, a new event type.
PARI	Pari-Passu	Occurs when securities with different characteristics, for example, shares with different entitlements to dividend or voting rights, become identical in all respects, for example, pari-passu or assimilation. May be scheduled in advance, for example, shares resulting from a bonus may become fungible after a pre-set period of time, or may result from outside events, for example, merger, reorganisation, issue of supplementary tranches, etc.
PCAL	Partial Redemption With Reduction of Nominal Value	Securities are redeemed in part before their scheduled final maturity date with reduction of the nominal value of the securities. The outstanding amount of securities will be reduced proportionally.
PINK	Payment In Kind	Interest payment, in any kind except cash, distributed to holders of an interest bearing asset.
PLAC	Place of Incorporation	Changes in the state of incorporation for US companies and changes in the place of incorporation for foreign companies. Where shares need to be registered following the incorporation change, the holder(s) may have to elect the registrar.
PPMT	Instalment Call	An instalment towards the purchase of equity capital, subject to an agreement between an issuer and a purchaser.

CAEV	Event	Description
PRED	Partial Redemption Without Reduction of Nominal Value	Securities are redeemed in part before their scheduled final maturity date without reduction of the nominal value of the securities. This is commonly done by pool factor reduction.
PRI0	Priority Issue	Form of open or public offer where, due to a limited amount of securities available, priority is given to existing shareholders.
REDM	Final Maturity	The redemption of an entire issue outstanding of securities, for example, bonds, preferred equity, funds, by the issuer or its agent, for example, asset manager, at final maturity.
REDO	Redenomination	Event by which the unit (currency and/or nominal) of a security is restated, for example, nominal/par value of security in a national currency is restated in another currency.
REMK	Remarketing Agreement	Purchase and sale of remarketed preferred equities/bonds through the negotiation of interest rate between the issuers and the holders.
RHDI	Intermediate Securities Distribution	The distribution of intermediate securities that gives the holder the right to take part in a future event.
SHPR	Shares Premium Dividend	This corporate event pays shareholders an amount in cash issued from the shares premium reserve. It is similar to a dividend but with different tax implications.
SMAL	Smallest Negotiable Unit	Modification of the smallest negotiable unit of shares in order to obtain a new negotiable unit.
SOFF	Spin-Off	A distribution of subsidiary stock to the shareholders of the parent company without a surrender of shares. Spin-off represents a form of divestiture usually resulting in an independent company or in an existing company. For example, demerger, distribution, unbundling.
SPLF	Stock Split/Change in Nominal Value/Subdivision	Increase in a corporation's number of outstanding equities without any change in the shareholder's equity or the aggregate market value at the time of the split. Equity price and nominal value are reduced accordingly.
SPLR	Reverse Stock Split/Change in Nominal Value	Decrease in a company's number of outstanding equities without any change in the shareholder's equity or the aggregate market value at the time of the split. Equity price and nominal value are increased accordingly.
SUSP	Trading Status: Suspended	Trading in the security has been suspended.
TEND	Tender/Acquisition/Takeover/Purchase Offer	An offer made to holders by a third party, requesting them to sell (tender) or exchange their securities.
TREC	Tax reclaim	Tax reclaim.
WRTH	Worthless	Booking out of valueless securities.
WTRC	Withholding Tax Relief Certification	Certification process for withholding tax reduction or exemption based on the tax status of the holder.
XMET	Extraordinary or Special General Meeting	Extraordinary or special general meeting.

6.5 Payment management of asset servicing proceeds

All asset servicing proceeds in EUR (being cash or securities) for securities eligible in T2S are paid into the DCA accounts of the client. For non-EUR proceeds, the related CBL cash account will be credited.

If the proceeds are not LuxCSD eligible at all, clients will be asked to provide the delivery details to LuxCSD to execute the payment accordingly.

All proceeds are paid upon receipt of funds in the original payment currency as determined by the issuer, on condition that the currency is recognised as eligible. The automatic foreign exchange service enables clients to have all income and redemption payments credited in the currency of their choice.

Clients may apply for a deduction of holding from the entitled position for certain events on CEU-issued securities (German market) to exclude such positions from the payment process by sending a Swift Corporate Action Instruction or Xact Web Portal instruction with a dedicated wording in the narrative field "NEW DEDUCTION INSTRUCTION".

In respect of ESMA regulation (EU) 2017/392 Article 86.3, where a corporate action will reduce the balance of a securities account, the securities and cash settlement instructions regarding the relevant securities issue will not be processed until the corporate action has been fully processed by the (technical) issuer CSD (i.e. other CSD), and respective confirmations have been received. This may lead to a desynchronisation of the cash and securities bookings.

Payments related to securities eligible in T2S

Payment processing

As a general rule, LuxCSD will process corporate actions payments on the same day as received from the market; it assumes that the following markets/systems need to be opened:

- Market, T2 and T2S for payments in cash,
- Market and T2S for payments in securities.

Whenever the payment cannot be processed the same day (e.g. late receipt of proceeds, reconciliation issue, technical issue), it will be done the next possible T2S settlement cycle.

To pay the LuxCSD clients, LuxCSD will generate each payment as already matched instruction in T2S (sese.023). Only free of payment instructions will be used to distribute/debit securities proceeds to clients. LuxCSD will not use against payment or with payment instructions to distribute asset servicing proceeds to clients.

The payment instruction are generated in the proceed distributed by underlying corporate action, for example, cash or/and securities. In case of multiple outturns, the payment instructions are generated per proceed. Whenever there are several movements for the same event which are processed at the same time, the MT566 message to client will include both movements.

The payment instruction will be linked to the underlying corporate actions event by showing the related corporate action reference.

The payment of fractions is subject to a separate payment instruction.

The payment instructions are not subject to partial settlement.

Cash distributions

All payments in T2S eligible currencies are paid to the client's DCA in Central Bank Money.

Clients can open several DCAs linked to their securities account in T2S, however all corporate action cash proceeds will be always paid to the client DCA that is setup as default DCA in T2S at security account level.

Clients will receive all T2S payments on an "upon receipt of funds" basis (URF). LuxCSD will initiate the payment in T2S as soon as the cash proceeds are received from the market, expected in the morning. The latest deadline to distribute the T2S eligible proceeds to clients the same day will follow the T2S deadline of 16:00.

Each asset servicing payment will be generated per proceed as well as the related corporate action confirmation. In case of multiple outturns, all movements will be included in the corporate action notification if processed at the same time.

Proceeds credited are confirmed to clients via Xact Web Portal, Xact File Transfer and Xact via Swift MT566 messages.

Securities distributions

All T2S eligible securities proceeds are paid to the client's securities accounts in T2S.

Clients will receive all T2S securities payments on an "upon receipt of proceeds" basis. LuxCSD will initiate the payment in T2S as soon as the securities proceeds are received from the market. The latest deadline to distribute the T2S eligible proceeds to clients the same day will follow T2S deadline of 18:00.

Each asset servicing payment will be generated per proceed as well as the related corporate action confirmation. In case of multiple outturns, all movements will be included in the corporate action notification if processed at the same time.

The debit of the basis securities will be processed together with the last credit of proceed (being cash or security movements).

Proceeds credited are confirmed to clients via Xact Web Portal, Xact File Transfer and Xact via Swift MT566 messages.

Detachment

On detachment date at the close of T2S business day, LuxCSD applies the blocking at securities level to prevent the execution of client settlement instructions as of this date.

Payments related to securities that are non-T2S eligible

Income payments

Income and redemption proceeds will not be allocated for LuxCSD's settlement processing. The proceeds will be paid to the clients into an external cash account¹ in CBL assigned in the Account Application Form.

Payments are released on the relevant payment date, once confirmed by our depository or agent and reconciled. Payments can be booked to a client's account at multiple times during each business day. This enables immediate release of payments when funds are received. The credit to the client's external cash account may be delayed if payment has not been received, reconciled or validated on time (for example late information on market).

Income and redemption amounts are credited to client accounts with value date the date of the actual receipt of the funds. Confirmation of income and redemption payments is available via:

- Confirmation of Income and Redemption Proceeds Report in Xact Web Portal;
- Xact File Transfer in XML and PDF format; or
- Xact via Swift MT566 (Corporate Action Confirmation), the standard usage of which may be replaced in exceptional cases by MT568 (Corporate Action Narrative).

Corporate action payments

All cash and LuxCSD-eligible securities proceeds resulting from a corporate action are credited on an upon receipt basis only.

Settlement and value dates mentioned in the notifications are those officially announced in the event's terms and conditions. Actual credit may, however, take place later due to practical reasons, for instance different time zones and reconciliation purposes.

LuxCSD will not be responsible for any damage incurred due to a delayed credit of proceeds if such a delay is beyond its responsibilities.

Proceeds booking on events may happen on a unique or on an ongoing (rolling) basis depending on whether the proceeds (cash or securities) will be released by the agent only once after the corporate action's deadline, or at multiple points in time during the corporate action. The latter usually applies to events with long life cycles such as conversion options or warrant exercises.

Proceeds credited are confirmed to clients via Xact Web Portal, Swift MT566 messages and Xact File Transfer.

Clients receiving securities from a corporate action event will be deemed to indemnify LuxCSD for any taxes, penalties, interest thereon and other costs that LuxCSD may incur as a result.

New payments following a reversal of an income payment

Whenever a new payment is applicable following a reversal execution of income events, the details are announced via an MT564 Corporate Action Notification and via an MT564 Income Pre-Advice Report (IPAR). Clients that were previously entitled but are no longer entitled due to the record date or ex-date change will not be notified of the new payment.

The new payment execution is confirmed via an MT566 Corporate Action Confirmation. It will be linked to the MT564 IPAR of the new payment.

1. A cash account that the client maintains with its Central Bank or CBL.

6.6 Transaction management

Transaction management refers to corporate actions¹ on flows (pending instructions). It includes market claims (reverse market claims), transformations and buyer protection.

The rules described in this section are standard procedures which may vary in some instances.

Market claims and reverse market claims

Market claims and reverse market claims refer to the process of the reallocation of the proceeds of a distribution to the contractually entitled party. The market claim and reverse market claim lifecycle includes detection and compensation of market claims or reverse market claims.

Detection rules

LuxCSD automatically processes the detection of market claims and reverse market claims for both intra-CSD and cross-CSD transactions. No detection will occur on cross-border transactions in markets where no market claim or reverse market claim process is in place.

All settlement instruction types, whether free of or against payment, are subject to market claims and reverse market claims detection.

Only matched instructions (including CCP transactions for LuxCSD-issued securities) are detected to be eligible for market claims.

For non CCP transactions on CEU-issued securities, the detection of market claims is on settled trades.

Market claims are detected from the end of the record date (or once the instruction settles in the case of a reverse market claim) and subsequently in real time during a detection period of 20 business days after the record date.

Market claims or reverse market claims apply to all distribution events:

- ACCU MAND: Accumulation
- BONU MAND: Bonus Automatic
- CAPD MAND: Capital Distribution
- CAPG MAND: Capital Gains Distribution
- DECR MAND: Decrease in value (Share)
- DRCA MAND: Cash Distribution from Non-Eligible Securities
- DRIP CHOS: Dividend Reinvestment (without debit of basis security)
- DVCA MAND: Cash Dividend
- DVCA CHOS: Currency Option on Dividend
- DVOP CHOS: Dividend Option (without debit of basis security)
- DVSE MAND: Stock Dividend
- INTR MAND/CHOS: Interest Payment
- LIQU MAND: Partial Liquidation (without debit of basis security)
- PINK MAND: Payment in Kind
- PRED MAND: Partial Redemption Without Reduction of Nominal Value
- RHDI MAND: Rights Distribution
- SHPR MAND: Shares Premium Dividend
- SOFF MAND/CHOS: Demerger/Spin-off (without debit of basis security)

1. In this section corporate action refers to both income and corporate action events.

SPLF MAND: Stock Split (without debit of basis security)

Note: PRED events are eligible for detection in the International market, but they are not eligible for compensation.

Key dates

The use of the settlement date rule or the trade date rule is aligned with the T2S accounting model and is based on the quantity type of the financial instrument.

The settlement date accounting rule applies for securities in nominal.

The trade date accounting rule applies for securities in units (this can apply to bonds). No compensation will be paid if the settlement instruction of one of the parties does not include the trade date.

Note: German flat bonds transactions follow the trade date accounting rule.

Settlement date accounting rule

A market claim is generated if a transaction in nominal shows a requested settlement date prior or equal to record date but is only settled after record date.

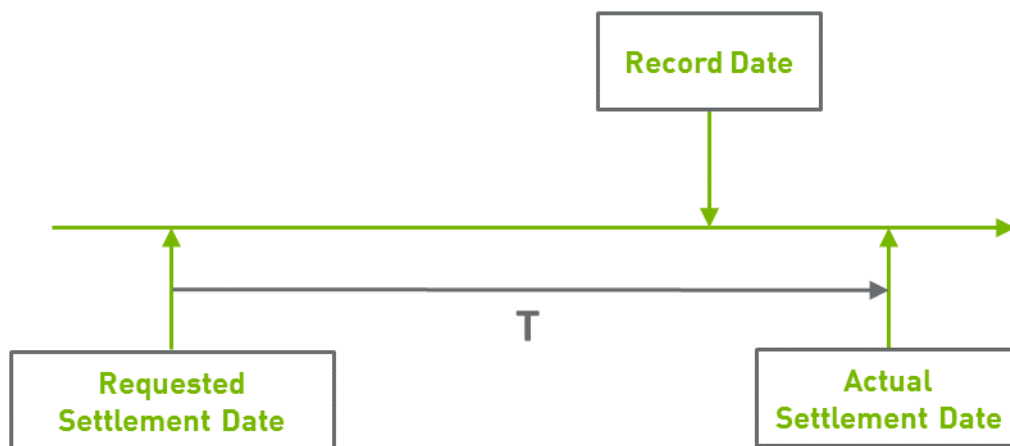

No reverse market claims can be generated for settlement date accounting rule as there is no ex-date.

Trade date accounting rule

A market claim is generated if a transaction in units shows a trade date prior to ex-date (cum coupon) but is only settled after record date. the direction of market claim is from the seller to the buyer.

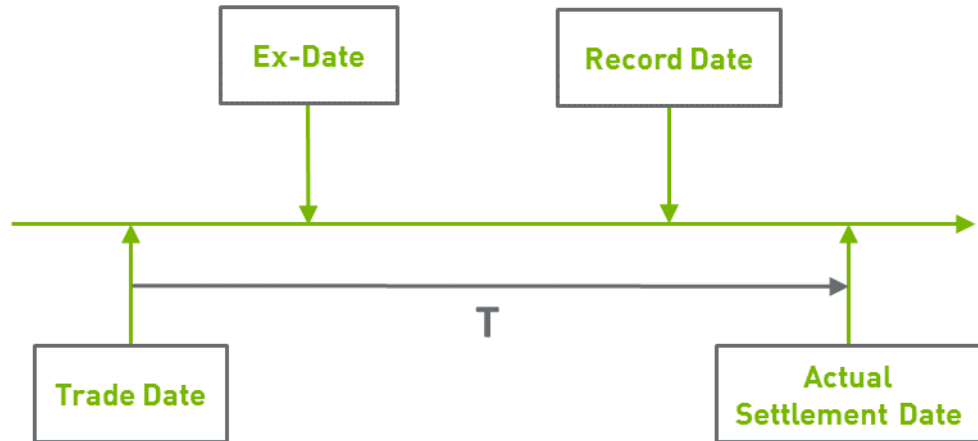

A reverse market claim is generated if a trade date is on or after ex-date (ex coupon) but is already settled prior to or on record date. The direction of reverse market claim is from the buyer to the seller.

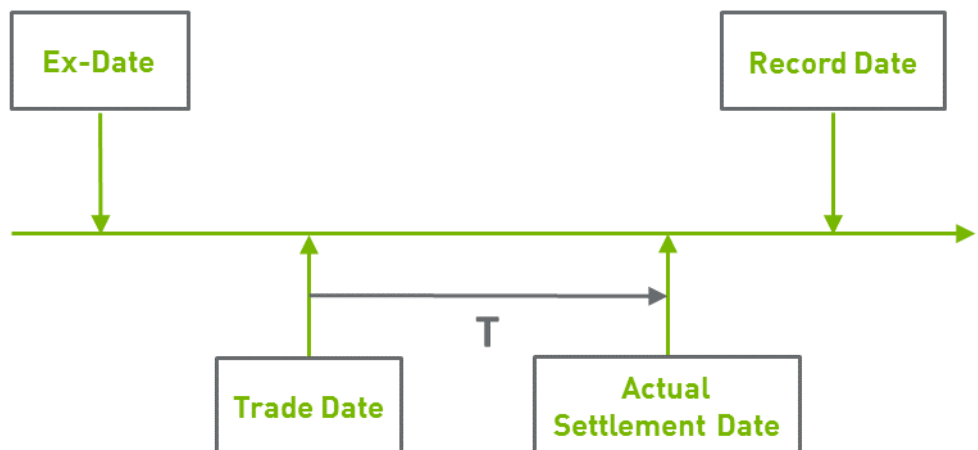

Opt-out, ex and cum indicators

Clients can specify in their settlement instructions if they want their trades to be excluded from the generic market claims or reverse market claims detection of LuxCSD. This can be done via the opt-out indicator.

Clients can specify in their settlement instructions if they want their trades to be treated as ex or cum irrespective of the trade date. This can be done via the ex or cum indicators.

Indicator	Description	ISO 15022 Swift field/qualifier
Opt-out	No automatic market claims detection	:22F::STCO//NOMC
Ex	Ex coupon	:22F::TTCO//XCPN
Cum	Cum coupon	:22F::TTCO//CCPN

These indicators are considered for Instructions processed by T2S where the matching of these indicators is mandatory if included in one of the instructions.

Compensation processing

Compensations are generated for markets where a market claim and reverse market claim process is in place.

- For T2S markets (excluding Austria and Germany), compensations are generated on record date end of day when the underlying instruction is at least matched (settled in case of reverse market claims), regardless of the payment status of the related corporate action event.
- For Austria and Germany, in order to comply with local market practice, compensations are generated based on matched instructions but only upon execution of the corporate action event.

Market claims in T2S markets with multiple proceeds of which one is non-T2S eligible for a transaction with a counterparty outside of LuxCSD only the T2S eligible proceed will be compensated and reported with a status "compensated".

For intra-CSD and cross-CSD trades, LuxCSD automatically generates the market claim or reverse market claim compensation on behalf of clients. These claims are generated via matching settlement instructions on client accounts. For cash compensations, this corresponds to an against payment Instruction with zero quantity of securities.

German market

For against payment instructions with zero quantity of securities (PFoD) generated as part of market claims, instead of one "net" against payment instruction with zero quantity of securities, there are two against payment instructions with zero quantity of securities:

- a "gross" transaction not considering the tax deduction;
- an overnight bulk tax adjustment to get to the same "net" result as before.

The Tax Credit Report available in Xact Web Portal explains the different daily market claim tax adjustment instructions.

The market claims or reverse market claims instructions have:

- the same trade date as the one of the underlying settlement instruction;
- the intended settlement date which is the latest date between the payment date of the event; and
- the intended settlement date of the underlying transaction; and
- the same status (that is, "On Hold" status) as the one of the underlying instruction at the time the compensation Instruction is created. The client can release this "On Hold" instruction by using the "Hold/Release" functionality in Xact Web Portal.

Market claims proceeds are paid to the client's account as specified in their settlement instruction. If no DCA is indicated, the market claim is paid to the DCA of the client being setup as default DCA in T2S at security account level.

Payments are compensated by means of separate cash bookings upon receipt of confirmation from local agents.

Securities proceeds are credited on client account via a settlement instruction.

For cross-CSD transactions with a counterparty in a market where a market claim and reverse market claim process is in place, market claims and reverse market claims will be generated following the market rules of the traded security. For more information about local market rules, please refer to the Entitlement Compensation Rules information presented for each market link on the LuxCSD website.

Blocking option service for compensation instructions

Clients have the possibility to control the release of the settlement compensation instruction by subscribing to the blocking option service.

This service is only available for corporate action events and free of payment market claim instructions, where the client is the seller.

The Blocking Option service is available for reverse market claims.

LuxCSD creates a compensation Instruction with the "On Hold" status on behalf of subscribed clients. Clients will be able to release this instruction for settlement via Xact Web Portal with the "Hold/Release" functionality or via MT530.

For non-subscribed clients, the compensation instruction will be processed as a normal settlement instruction.

Tax rate on the compensation and tax adjustment

For intra-CSD trades, the tax rate of the compensation follows the market rule (gross or net of the maximum withholding tax rate).

Whenever a tax adjustment is needed, a separate settlement instruction will be generated. This corresponds to an against payment instruction with zero quantity of securities, that is visible via Xact Web Portal.

The tax adjustment is reported in the MT566 Corporate Action Confirmation.

Market claims and reverse market claims reporting

Any market claim or reverse market claim subject to compensation by LuxCSD is notified via the MT564 Claim and Reversal Advice. The tax adjustment amount linked to a market claim or a reverse market claim is also included in the MT564 Claim and Reversal Advice as an additional cash movement. Any cancellation of a reported market claim or reverse market claim will also be sent via the MT564 Claim and Reversal Advice (see [Asset Servicing reports](#) on page 8-7).

The reversal of market claims and reverse market claims is notified via the Claim and Reversal Advice.

An account by account overview of all potential market claims related to a client's trades in securities is provided by the Custody Market Claims Report (see [Asset Servicing reports](#) on page 8-7).

Market claims and reverse market claims in securities are included in the MT53x reporting and can also be included in the settlement reporting (MT54x). Clients currently have the option to include or exclude the reporting of compensation Instructions in securities by selecting or deselecting "Custody Proceeds" from their MT54x reporting subscription. "Custody proceeds" also include securities proceeds resulting from corporate action events.

Market claims and reverse market claims in cash are included in the cash reporting (MT9xx).

Market claims and reverse market claims are also visible in Xact Web Portal.

Transformations

Transformation is a process by which pending transaction, on or after entitlement date, are cancelled and replaced by the new transactions in accordance with the terms of the reorganisation.

The transformation lifecycle includes detection of transformation, cancellation of underlying instruction and re-instruction, whenever applicable.

Detection rules

For mandatory reorganisation events (with or without options), LuxCSD detects all pending matched trades (including CCP transactions for CEU-issued securities). The detection of transformations is based on entitlement date, that can be either:

- Record date or effective date where applicable, for transformations related to mandatory reorganisations without options;
- Market deadline, for transformations related to mandatory reorganisations with options (see [Corporate action events](#) on page 6-8).

Transformations are detected from the end of the entitlement date until the end of the detection period (20 business days after entitlement date) and if the Settlement Instruction has been identified as eligible. For non CCP transactions on CEU-issued securities, the detection of transformations is on settled trades. This period has no material impact as no settlement instruction can be received on a matured security.

Transformations will only be processed once a day after the end of day.

The events eligible for the LuxCSD transformation detection process on intra-CSD and cross-border transactions are listed below:

BONU CHOS ^c	Bonus Issue/Capitalisation Issue (with interim line)
CHAN MAND ^{a,b}	Change/Reclassification (German market)
CONV MAND ^{a,b}	Conversion of securities
DRIP CHOS ^c	(with interim line)
DVOP CHOS ^c	Dividend Option with Rights (with interim line)
DVOP MAND	German dividend option event on Cash Line
EXOF MAND/CHOS ^{a,b,c}	Exchange Offer
EXRI CHOS ^{a,c}	Bonus Rights/Subscription Offer (with interim line)
EXTM CHOS ^{a,c}	Extension Option
EXWA MAND/CHOS ^c	Warrant Exercise
LIQU MAND ^{a,b}	Liquidation
MCAL MAND	Early Redemption
MRGR MAND ^b /CHOS ^c	Merger
PARI MAND ^b	Pari-Passu

PCAL MAND ^a	Partial Redemption by Face Value Reduction
REDM CHOS ^c	Mandatory with Choice Redemption in Cash or Shares at the holder's Option
REDM MAND ^b	Redemption in Shares at the Issuer's Option/Final Redemption
SOFF MAND/CHOS ^a	Demerger/Spin-off
SPLF MAND ^{a,b}	Stock Split
SPLR MAND ^b	Reverse Stock Split
TEND MAND ^b	Tender Offer / Purchase Offer / Squeeze Out (German market)
WRTH MAND ^{a,b}	Worthless

-
- a. Only events with a debit of basis securities.
b. Reorganisation events with settlement instructions that have a trade date after the event record date will not be transformed: Clients are requested to contact their counterparty to align on a bilateral basis for their entered, not transformed trades.
c. For the German market, these events have temporarily been excluded from Standard 10.

Cancellation of underlying instruction and re-instruction

LuxCSD cancels pending matched intra-CSD and cross-border transactions whether the basis security code changes or not and whether transformations are applicable on the market or not.

For markets where transformation is applicable, LuxCSD re-instructs transformations for:

- any pending matched intra-CSD instructions;
- any pending matched domestic instructions in LuxCSD or CEU-issued securities.

LuxCSD does not re-instruct transformations for:

- delivery free of payment without matching;
- any other instructions that do not fall under the categories described above.

For markets where no transformation is applicable, LuxCSD does not perform any re-instruction.

Specific rules per market, if any, are outlined in the Market Guides on the LuxCSD website.

When LuxCSD does not re-instruct the transformation, the client has to input new instructions using the correct ratio.

For intra-CSD and cross-CSD trades, LuxCSD automatically generates re-instructions via matching settlement instructions on client accounts. For a cash re-instruction this corresponds to an against payment Instruction with zero quantity of securities.

The re-instructions are generated if the below conditions are met:

- the cancellation of the underlying instruction has been successfully executed;
- the mandatory reorganisation event has been paid;
- the underlying instruction was not flagged as Opt-Out.

The securities quantity and cash amount in the re-instruction is calculated as in the terms of the reorganisation event.

Re-instructions are generated with the same status as the underlying instruction. MT54x Settlement instructions with :22F::STCO//TRAN can be cancelled or modified by LuxCSD clients via Xact Web Portal.

In case of multiple outturns, the re-instructions will settle independently (no link to each another).

The re-instructions are generated with:

- the same trade date as in the underlying instruction;

- the requested settlement date being the latest date between the payment date of the entitlement and the requested settlement date of the underlying transaction.

Opt-out indicator

Clients can specify in their settlement instructions if they want their trades to be excluded from the generic transformation detection of LuxCSD. This can be done via the opt-out indicator.

Indicator	Description	ISO 15022 Swift field/qualifier
Opt-out	No automatic transformation	:22F::STCO//NOMC

Note: Clients can use the flag in intra-CSD trades. If one of the counterparties includes one of these indicators in the Instruction, and the market in which the traded security is deposited, supports its usage, this flag will prevent automatic processing of transformation compensation (opt-out).

These indicators are considered for instructions processed by T2S where the matching of these indicators is mandatory if included in one of the instructions.

For cross-CSD instructions, LuxCSD performs detection on the basis of STCO value mentioned in the client instruction.

Transformation reporting

As per the Corporate Actions Joint Working Group (CAJWG) standards, transformations are not subject to Corporate Action reporting.

Instructions that are cancelled as a result of transformations are reported in the MT548 Settlement Status and Processing Advice (See [Clearing and settlement reports](#) on page 8-4).

Outturn in cash and securities are posted to client accounts and reported in the related cash and settlement reports.

Re-instructions are included in settlement reporting (MT54x) and Statements of Transactions (MT53x).

Clients receive cash reporting (MT9xx) whenever the re-instruction is cash related.

The reporting includes a narrative with additional information relevant to transformations to ease the reconciliation.

The reports are also visible in Xact Web Portal.

Buyer protection

Buyer protection is a process where a buyer who has yet to receive the underlying securities of an elective corporate action instructs the seller in order to receive the chosen proceeds. The objective of buyer protection is to ensure that the buyer in a pending transaction, who has acquired the right to elect in an (elective) reorganisation, will be able to express the preferred option, and receive the proceeds of their choice.

LuxCSD applies a manual buyer protection mechanism in line with the T2S corporate action standards. To facilitate the buyer protection process, LuxCSD provides the following to clients:

- Corporate Action Notification messages (Notification, IPAR and CA Reference Data report) to clients including the buyer protection deadlines whenever it is applicable on the market. This information is reported in the following structured fields: Election to Counterparty Market deadline; Election to Counterparty Response Deadline and Guaranteed Participation Date.
- The CASG compliant template for the buyer protection invocation.

Even though not offered by the market (no deadlines provided), the buyer can invoke the buyer protection mechanism. In this case, LuxCSD will process the buyer protection manually and on a “best efforts” basis for the client.

The buyer protection deadline is visible in Xact Web Portal.

6.7 Tax services

LuxCSD provides clients with a number of tax services in various markets:

- Tax documentation service;
- Relief at source and quick refund;
- Standard refunds;
- Proactive tax reclaim;
- Tax certificate queries, tax attestation request uploads and queries via Xact Web Portal;
- Client information form.

Tax documentation service

The tax documentation service covers the supply of information relating to:

- Certificates received from clients in order to obtain exemption from, or a reduction of, withholding tax at source on taxable events (referred to hereafter as **certificates**); and
- Tax refund claim forms (referred to hereafter as **refund forms**) to reclaim all or part of the withholding tax initially paid on taxable events.

The main features of the tax documentation service are:

- The issuance of Acknowledgements of receipt for each certificate/refund form submitted and the confirmation of validity;
- The issuance of an “Expiry Report” in respect of certificates due to expire in one month’s time.

Every client that sends a certificate/refund form will receive, as appropriate, the documents described in the following sections. Clients are responsible for evidencing that they have sent the relevant certificates/refund forms to LuxCSD. Clients are responsible for evidencing that they have sent the relevant certificates/refund forms to LuxCSD.

Any certificate addressed to LuxCSD must be accompanied by a cover letter containing the account number and purpose of the certificate duly mentioned. Any refund form addressed to LuxCSD must be accompanied by a Letter of Request to LuxCSD. If the client does not provide the Letter of Request, LuxCSD reserves the right to reject such refund forms.

To ensure efficient processing, clients can only send certificates for accounts already open within LuxCSD. If a client sends a certificate with multiple accounts, where some of them are not open in LuxCSD yet, LuxCSD reserves the right to reject such certificates.

Depending on the investment market requirements and on the specificity of documentation for tax relief, clients may request the duplication of the certificates already submitted and validated by LuxCSD from one account to another.

Consequently, LuxCSD offers to its clients the possibility to duplicate (where applicable) original and valid tax certification via unsolicited instruction (Swift, Xact Web Portal or Xact File Transfer) per market and having below mandatory text completed accordingly:

The duplication request should refer to the initial received and still valid original tax documentation (duplication of duplicated certificates is not acceptable). The duplication will generate a new tax certification registration with a unique reference, will be charged according to the usual tax certification processing fee and, once registered, will be available via Xact Web Portal.

Important Note: Duplication of tax certificates older than 10 years is not performed by LuxCSD. LuxCSD reserves the right to refuse any request for duplication of a tax certificate whose original is not retrievable. In such case, the client shall either provide new tax certificate(s) or a copy of the original tax certificate, along with the Swift instruction to duplicate.

Request for duplication of tax certificates

ATTN: Tax Services

Market:

Source Account:

Destination Account:

LuxCSD references of the impacted certificate(s):

We hereby confirm that above-mentioned original tax certificate(s) is/are still valid and should not be revoked.

We irrevocably authorise LuxCSD¹ to apply tax relief based on the information contained in the original tax certification duplicated for the destination account.

We hereby appoint LuxCSD and LuxCSD's depository for the Securities as our attorneys-in-fact with authority to collect and forward the tax certification or a copy of the tax certification, any attachments and any information relating to it to the tax authorities if these prove relevant to any administrative or legal proceedings or official inquiries undertaken or threatened.

We accept full responsibility and indemnify LuxCSD in the case of any claims or additional taxes, interest thereon or penalties levied by tax authorities in connection with any payments made in reliance upon this duplication of certification including any additional information provided in connection to it.

We certify, under penalty of perjury, that the information contained in the tax certification is true, correct and complete.

1. LuxCSD refers to LuxCSD S.A., registered office at 42, avenue John F. Kennedy, L-1855 Luxembourg, and registered with the Luxembourg Trade and Companies Register under number B 154.449.

Acknowledgements of documentation

Depending on the communication means the client is subscribed to, an acknowledgement is either mailed or communicated via Swift message for each certificate/refund form submitted to LuxCSD. For certificates, per depository/or tax agent, one acknowledgement is issued per account whereas for standard reclaims, one acknowledgement is issued per requested amount.

A unique identification number is assigned to each certificate/refund form submitted to LuxCSD. This number, which is included in the acknowledgment, needs to be referenced in all further submissions and queries related to the certificate/refund form in question.

Acknowledgements issued in respect of certificates/refund forms considered valid (that is, complete as to form and content) by LuxCSD include a Withholding Tax Certification Confirmation, summarising the details of the certificates/refund forms allowing our clients to reconcile. Those acknowledgements are by default sent by Swift or Xact Web Portal message (referred hereafter as digital means of communication) but can be sent via regular mail upon request from our clients. Any certificates/refund forms that are considered invalid are returned to clients by registered mail for amendment, with the reason duly noted on the accompanying acknowledgement.

In the event where the client has provided certificates/ refund forms (as applicable) to LuxCSD via registered mail or via Swift within the requested deadline, LuxCSD shall confirm acknowledgement of the documents so provided by the client via registered mail or via Swift. Subject to the client having established that the documentation has been sent to LuxCSD, as per above, LuxCSD shall not at any time be held liable for any loss or damage caused by the non-processing of the certificates/ refund forms, unless the client has informed LuxCSD in writing of the missing acknowledgement prior the client instruction deadline, and no later than one month following the date the client sent its documentation, and LuxCSD is not able to demonstrate that such acknowledgement was sent to the client, or in the case of LuxCSD's gross negligence or wilful misconduct in relation thereto.

Expiry Report

About one month before the expiry date of any standing certificate, a reminder (Expiry Report) is sent by post or communicated by digital means of communication to the client with a summary of the details of that certificate.

Tax certificate query

Clients can query inventory information about tax certificates in Xact Web Portal. The tax certificate query provides a comprehensive record of tax certificates received as well as the certificate validity dates. Clients have the possibility to define their queries by account, market, depository, beneficial owner and/or event type.

For further information regarding tax certificate and tax refund queries see [Chapter 8. Clearing and settlement reports](#).

Tax attestation query

Clients can use the Tax Attestation Query about German Tax Vouchers in Xact Web Portal (will be extended to further markets in the future).

Tax attestation request upload

Clients can use the Tax Attestation Request Upload functionality to request German Tax Vouchers (will be extended to further markets in the future).

Relief at source and quick refund

LuxCSD offers relief at source and quick refund to clients whenever such service is available via its depository/or tax agent, as specified in our Market Taxation Guides and Announcements.

Tax notifications

For forthcoming income and corporate action events in the markets concerned for which LuxCSD offers relief at source or quick refund, LuxCSD provides its clients with pre-advice based on their entitled positions on the record date in the form of tax notifications via Swift, with details concerning the relief at source or quick refund process and references to Market Taxation Guide, Announcements and Tax Matrix, if applicable containing market-specific tax criteria. As a result, clients can report their entitled positions in good time and submit the necessary documents to LuxCSD in order to benefit from relief or quick refund.

Tax notifications are only sent for the income and corporate action events for which LuxCSD offers a tax service to its clients. Clients will consequently not receive any tax notifications for taxable income and corporate action events for which no relief at source or quick refund is offered by its depository or the tax agent.

Tax instructions

Any application for relief at source or quick refund on income or corporate action events shall be submitted to LuxCSD by the relevant account holder. The account holder is solely responsible for the content, continuing accuracy and completeness of any application and certification submitted with respect to securities held on its account(s) with LuxCSD (including any certifications from the underlying final beneficial owner).

LuxCSD does not provide any tax advice and by submitting any request the client confirms that (i) it has made all relevant assessments, (ii) it has sought relevant professional advice and (iii) it does not rely on LuxCSD for the purposes of determining the applicable tax rate applicable to the underlying beneficial owner of the taxable event.

Clients may instruct using the following media:

- Xact Web Portal;
- Xact File Transfer;
- BO Upload¹;
- Formatted Swift Corporate Action Instruction, MT568, MT599 message by using the BIC address: CEDELULLXXX or LUXCLULLXXX.

Instructions received from clients are validated by LuxCSD and processed accordingly.

An additional fee will be applied to free format messages, unsolicited instructions and manual repairs to the below instruction types:

- Free format messages; and
- Unsolicited instructions (Swift, Xact Web Portal or Xact File Transfer) where the corporate action reference ID is missing and for which the client has received this corporate action reference ID previously in the related Corporate Action Notification before sending the instruction. If several events are announced within the same period, unsolicited instruction might be rejected; and
- Any client Formatted Corporate Action Instruction received via Swift, Xact Web Portal or Xact File Transfer where the required information has been incorrectly populated through dedicated structured fields (manual repairs).

Incorrectly formatted instructions provided via Swift or Xact Web Portal that are automatically rejected will immediately trigger a Swift MT567 Status and Processing Advice indicating the reason for rejection.

Instruction format

To ensure straight-through processing and to benefit from the full life cycle of information, clients must send tax instructions using an available connectivity method:

- Standard rules for the completion of the Swift, as described in the Xact via Swift User Guide, must be followed. Any additional information required as described in the tax notification must be included.
- For instructions sent as free-format messages, automatic validation and processing is not applicable.

Free-format instructions can be accepted, containing the following mandatory data to ensure validity:

- Exact event type;
- CBL Corporate action reference ID (if any);
- Client account number;
- Corporate action option number
- Corporate action option code indicator
- Quantity instructed (please refer to the eligible balance on the notification);
- The financial instrument identification number (ISIN or Common Code);
- Tax rate applied for;
- Any additional information required as described in the tax notification.

1. Depending on market practice the BO list upload must be complemented by an instruction as indicated in the tax notification.

For BO lists uploaded via the BO Upload application clients should submit BO lists in the predefined format. The following data are mandatory to ensure validity of the BO lists:

- Client account number;
- Security code (ISIN or Common Code);
- Security Name;
- CBL Corporate Action Reference ID (if any);
- Record date;
- Payment date (if applicable);
- Holding;
- Any additional information required as specified in predefined format of a BO list.

Clients must only include one instruction per instruction message. One instruction consists of: one event, one account number, one financial instrument identification number (ISIN or Common code), one tax rate (multiple BOs accepted per same tax rate applied).

If a client includes more than one instruction per message, or if the additional text field on formatted messages includes an instruction or contradicts with the instruction given in the structured fields, LuxCSD cannot be held responsible for any loss or damage caused. LuxCSD reserves the right to reject instructions not formatted as described above.

In the event that clients do not submit any application for exemption or for reduced tax rate on taxable income or corporate action events, the standard tax rate as per the market specifics (default action) will apply.

Late instructions

Instructions received after the LuxCSD deadline are handled on a "best efforts" basis, however, execution cannot be guaranteed. If the instruction received after the LuxCSD deadline cannot be executed, LuxCSD will apply the standard tax rate as per market specifics (default action) and reject the client's late instruction accordingly.

When a correctly formatted Swift corporate action instruction comes in after the LuxCSD deadline, clients receive an acknowledgement, advising the client that the instruction is after the LuxCSD deadline and will be processed on a "best efforts" basis. After feedback from the depositories/agents a revised processing advice is sent to clients.

Status and processing advice

Clients instructing via Swift or Xact Web Portal will receive a status and processing advice message for each tax instruction sent to LuxCSD.

Clients using Xact Web Portal can check the status of their instructions directly in Xact Web Portal and schedule the receipt of a Status and Processing Advice via Swift.

In order to receive acknowledgements via Swift, a valid Swift address is required and the check boxes for "Acknowledgement of messages" and "Include all media channels" must be checked in the Scheduled Reports details.

Incorrectly formatted instructions provided via Swift or Xact Web Portal that are automatically rejected will immediately trigger a Swift MT567 Status and Processing Advice indicating the reason for rejection.

If the tax instruction was sent using a free-format message, clients will not receive a status and processing advice and are responsible for monitoring the instruction execution.

Rejection of instructions

LuxCSD will inform the client about rejection of instruction in following cases:

- Instruction is incomplete or invalid (as per instruction format definition);
- The corporate action reference ID is missing, ISIN (or common code) and/or corporate action reference ID provided in the related instruction do not match with an event;
- Any additional requirements (as per tax notification) are not satisfied.

Clients will be notified about a rejection via MT567 Status and Processing Advice or via MT568 Swift with a reason of rejection noted.

General disclaimers

In the event that for any reasons, clients do not receive the expected proceeds as per the tax certification and/or instruction provided to LuxCSD, the client shall request LuxCSD, within a period of three (3) working days from the payment date of the respective income or corporate action event, to perform the readjustment towards, if applicable, the relevant local custodian, paying agent or tax authority.

LuxCSD shall not be liable in the case where the client did not request such rectification from LuxCSD within the above timeframe.

Clients acknowledge and agree that, whenever benefiting from such relief at source or quick refund service, they shall provide to LuxCSD and/or the local tax authorities, promptly and upon request at any time of LuxCSD, such documentation that may be necessary to assist LuxCSD and/or its depository to prepare and process via standard refund tax reclaims on behalf of the underlying beneficial owners in order to recover the funds. LuxCSD shall not be liable in case the documentation is not provided.

Standard reclaims

With its tax services LuxCSD assists clients in obtaining tax refunds from taxation in various markets, whenever such service is available via its depository/or the tax agent, as specified in our Market Taxation Guides, Announcements and Announcements.

Clients acknowledge and agree that:

- The tax reclaim service offered by LuxCSD may be subject to changes depending on the local Tax Authorities, local depository or local tax agent; requirements,
- LuxCSD is authorised to process the tax reclaim with full reliance on the information provided by the clients, without any requirement for LuxCSD to verify the authenticity, completeness, accuracy or correctness of any such information and documents, and
- LuxCSD does not guarantee the acceptance of the reclaim or its payment by the local Tax Authorities, therefore, in the absence of any negligence of LuxCSD, LuxCSD shall not be held liable, and
- LuxCSD shall not be liable, however, for any indirect loss or damage caused by the tax reclaim procedure unless there is any negligence or wilful misconduct on the part of LuxCSD, LuxCSD, however, shall not be liable for any indirect or unforeseeable loss, claim, liability, expense or other damage unless such action or omission constitutes gross negligence or wilful misconduct on the part of LuxCSD.

Tax refund queries

Clients can query inventory information about tax certificates and tax refunds in Xact Web Portal. With the tax refund query clients can retrieve a list of refunds submitted to LuxCSD and track their status.

For further information regarding tax refund queries, see [Chapter 8. Reports and information services](#).

Proactive tax reclaim

To further assist clients in the reclaim process, LuxCSD offer the ProActTax reclaim service. As part of this service, LuxCSD generates and prepares reclaim forms and certifications for its clients, and it submits the forms and initiates the reclaim process with the relevant Tax Authorities, relevant depository or relevant tax agent on behalf of the beneficial owners upon receipt of the original validated and certified reclaim forms from clients.

Tax services on securities held outside the home market

Tax services offered for remotely deposited securities (not deposited via LuxCSD's local home depository) are only available via LuxCSD, whenever such specific service is specifically announced to clients either in our Market Taxation Guides, Announcements or tax notifications via Swift.

Client Information Form

An Information Form is available to notify LuxCSD of the name and address of the contact person/department to whom the new reports are to be mailed or communicated. If no such information is received, all information relating to withholding tax is sent to existing contact names or for the attention of the Taxation/Securities Department.

Client Information Forms are available from the Tax Help Desk or your Client Services or Relationship Officer.

Tax certification

LuxCSD accounts certified for U.S. tax purposes

It is mandatory for clients wishing to invest in any security that may distribute income or deemed income that is taxable/reportable for U.S. tax purposes to certify their LuxCSD account prior to making any such investment.

Please contact the Tax Help Desk for full details and LuxCSD templates to be used.

Withholding tax

Income from international securities may be subject to tax depending on the terms and conditions of the issue. The taxability for a given ISIN is also visible in the Codelist application and via Xact Web Portal.

Where withholding tax is applicable, tax relief may be available either at source or through a tax refund (regardless of the tax service offered on the domestic market).

Capital gains tax

Typically, there is no capital gains tax withheld through LuxCSD on international securities held in LuxCSD. However, capital gains tax may be payable on specific gains. LuxCSD does not assist in this regard. Please consult your tax advisor for further information.

Stamp duty

There is no stamp duty withheld through LuxCSD on securities held in LuxCSD. However, stamp duty may be payable on specific transactions. LuxCSD does not assist in this regard. Please consult your tax advisor for further information.

General disclaimer on Tax Services

In case of accounts opened to hold assets on a proprietary basis, LuxCSD will not treat by default any taxable events on assets held on such accounts as beneficially owned by the client for tax purposes. It remains the client's responsibility to ensure that any tax documentation provided to LuxCSD, including certificates, is reflecting the correct beneficial owner information for tax purposes, taking into account any underlying transaction to the extent relevant in any given market to establish beneficial ownership for tax purposes on assets held on the account.

6.8 General Meetings services

LuxCSD provides a general meetings service to clients (or to any third party appointed by the client in accordance with a power of attorney)¹ for equities and bonds held in custody.

For each meeting event, clients will receive the respective meeting notification, that can be either an AGM or an EGM.

For further details of the market concerned, please refer to the respective market link information on the LuxCSD website (under Products & Services / Market Coverage).

Additionally, LuxCSD informs clients about court meetings if and when information is provided to us.

Clients who do not want to use the service have the option to deselect meeting notifications through their Xact Web Portal subscription.

General Meetings service

Main features

The main features of the General Meetings service are as follows:

- Notification of meeting events via Xact Web Portal, Xact File Transfer and via Xact via Swift ISO 20022;
- Meeting entitlement notification;
- Provision of meeting agendas (always available in English);
- Split and partial voting;
- Power of attorney for voting;
- Handling of General Meetings instructions in ISO 20022 format or Xact Web Portal;
- Delivery of entry or admission cards for meetings, upon request;
- Blocking of securities, if applicable;
- Reporting of meeting results if received from the agent;
- Vote execution confirmation.

Content of instructions

Standard rules for the completion of the meeting instructions, as described in MyStandards and the Xact Web Portal User Guide.

LuxCSD reserves the right to reject message instructions not formatted as per recommendations.

Message types

Message purpose ISO 20022

Message type

Meeting Event Notification - seev.001/MT564 NEWM

The Meeting Notification message is sent by LuxCSD to clients/account holders or their respective third-party service providers.

1. In this §9.6, a reference to the client is to be read as a reference to the client or to its attorney, as the case may be.

LuxCSD uses multiple sources for the sourcing of information regarding general meetings, including service providers, depositories or issuer agents. Based on the information received by these sources, the Meeting Notification message is created and provided to clients.

Meeting Event Cancellation - seev.002 / MT564 CANC

The Meeting Event Cancellation message is sent by LuxCSD to clients/account holders or their respective third-party service providers to inform about a cancellation.

Meeting Entitlement Notification - seev.003

The seev.003 message performs the function of a certificate of holding by proving custody positions on a specific date during general meeting registration.

LuxCSD generally issues this message automatically for clients with an active subscription after the entitlement fixing date.

Meeting Instruction - seev.004

(Formerly MT565, but not supported by LuxCSD).

The Meeting Instruction message is sent to LuxCSD by a client/account holder of LuxCSD holding the right to vote, requesting LuxCSD to act upon one or several instructions.

Meeting Instruction Cancellation - seev.005

(formerly also MT565, but no longer supported by LuxCSD)

The Meeting Instruction Cancellation message is sent to LuxCSD by a client/account holder of LuxCSD holding the right to vote, requesting LuxCSD to cancel a previously submitted instruction.

General meeting instructions

The final instruction deadline for meeting events varies from market to market. Clients can send instructions up to the deadline as communicated within the meeting notification. Instructions received after the deadline will be executed on a “best efforts” basis.

Blocking of positions occurs where it is a market or Issuer requirement. Blocking commences when the instruction is submitted to the local market representative, the agent or the depository and continues until the Securities Blocking Period End Date, as communicated in the notification, has been reached.

LuxCSD performs several validations on a received instruction message. The validations can be dependant on certain qualifiers that were used in the notification message (such as non-votable resolution items), on qualifiers used within the instruction that LuxCSD does not process (such as short positions) or on the specific event and instruction context (such as a registration request without beneficial owner details).

Each received instruction or instruction cancellation will trigger a status message to the instructing party, indicating whether the instruction has been accepted or rejected. Additional status messages will be sent after the instruction is forwarded to the depository, selected provider, or issuer agent. The status message generally requires an active subscription; however, rejections due to the technical message validation failure will be reported to the sender of the instruction even with no subscription in place.

Cancellation and replacement of previous instructions

If instructions have already been processed and forwarded to the local market, the agent or the depository, the cancellation request will be handled on a “best efforts” basis.

Following an instruction cancellation, clients have the possibility to re-instruct. If a valid Meeting Instruction Cancellation Request ID (equal to the Business Message Identifier of the meeting instruction cancellation) is included in the new instruction, this is interpreted as a re-instruction, meaning LuxCSD will pass on the re-instruction only once the cancellation is confirmed by the LuxCSD market provider. If this functionality is not used, LuxCSD will process as an individual meeting instruction.

LuxCSD makes no guarantee as to the execution of such cancellation request and under no circumstances will it be liable for any loss or damage caused by a client's failure to comply with the cancellation and replacement procedure.

The cancellation request has to be submitted via Swift ISO 20022 or Xact Web Portal and will be processed and forwarded to the depository.

Handling of linked events

Linked events are events that are related. The notification of a corporate action event that is linked to a meeting shall contain the corporate action reference of the meeting event.

When a meeting event is linked to a corporate action offer event, clients must consider them as two separate events and avoid duplicating the exercising of their positions per option.

For example, if an instruction is sent for the CTEN or CEXC option for an Exchange Offer, Repurchase Offer or Purchase Offer, the client must not instruct for the same positions.

Positions that are instructed for a linked corporate action offer event are immediately blocked and the amount will be ineligible for the related meeting event.

Participation methods (instruction) and market specifics

LuxCSD supports specific participation methods during the instruction process:

EVOT for vote instructions, PRXY for proxy instructions and PHYS for attendance requests. Other participation methods are generally not supported.

Each participation method requires dedicated information to be provided:

General Meetings – Swift Reporting

Meeting Instruction (seev.004) – Participation Method

Instruction	Participation Method	Notification - Supported by CB?	Instruction - supported by CB?	Vote Details Section	Meeting Attendee Section	Proxy Section	Securities Registration Indicator	Rights holder section
Vote with/ without Registration	EVOT	✓	✓	Mandatory	Rejection	Rejection	Optional	Mandatory (if requested in seev.001 via „BO Disclosure“ = true)
Attendance	PHYS	✓	✓	Optional	Mandatory	Rejection	Rejection ³	
Proxy with/ without Registration	PRXY	✓	✓	Optional	Rejection	Optional ⁴	Optional	Mandatory for registration Optional otherwise
Registration	blank ²	n/a	✓ ²	n/a	n/a	n/a	Mandatory	
Not Voting	PHNV	✓	✗					
Correspondence	MAIL	✓ ¹	✗					
Virtual	VIRT	✓ ¹	✗					
Proprietary codes		✗	✗					

¹: When received from the market/issuer, the notification will be forwarded with the indicator “Supported By Account Servicer” set to FALSE. Any instructions on those events will be rejected.

²: Please note that Participation Method can only be blank for a Registration-only request. In all other cases, Participation Method is a mandatory field

³: Entrance card cannot be combined with a registration request. This needs to be instructed with two separate instructions.

⁴: At least one of the Vote Details or Proxy sections should be filled out for the Proxy with / without Registration instruction types.

Figure 6.1 Participation Method

Valid meeting instructions must include key details like ISIN, meeting ID, and account information. For entrance cards without voting rights, participation method PHYS should be used with the PHNV method specified in the meeting attendee section.

Meeting deadlines

If reported to LuxCSD, the Enrolment Market Deadline is forwarded to the LuxCSD client as received. It is expected to precede or be equal to the Vote Market Deadline.

The Enrolment Deadline is determined by LuxCSD based on the markets' STP capabilities.

The Vote Market Deadline is forwarded by LuxCSD as reported to LuxCSD.

The Vote Deadline is determined by LuxCSD based on the markets' STP capabilities.

LuxCSD reports the Vote Market Deadlines and Vote Deadlines in UTC time format (YYYY-MM-DDThh:mm:ss.sssZ).

As per the current market practice, Enrolment Deadlines are currently applicable to the German market only. However, the potential usage of these deadlines in other markets are not excluded.

The vote deadline for events received from issuer agents and where the instructions can be processed STP will be better than the deadlines for events where no instructions in MX format can be sent to the market.

For registered shares, the "Registration Securities Deadline" indicates by when a registration must be instructed.

The Registration Market Deadline is expected to be before or equal to the Vote/Enrolment Market Deadline.

The "Securities Blocking Period End Date" indicates that LuxCSD will block the instructed securities from the approval of the instruction to the Securities Blocking End Date.

Please note that date/time fields other than Vote (Market) Deadline may be reported in UTC time format, local time or local time with UTC offset.

Reminders

Following the initial notification and further updates, LuxCSD will send reminders to clients for the meeting event according to the following schedule:

- 1st reminder: Seven business days before Early Incentive Deadline;
- 2nd reminder: Seven business days before the Vote Deadline;
- 3rd reminder: Two business days before Early Incentive Deadline;
- 4th Reminder: Two business days before the Vote Deadline.

The reminder service is optional and can be deactivated on subscription level.

Note: A maximum of one reminder is sent per day.

Certificate of holding

In certain markets, issuers require a Certificate of Holding, which LuxCSD provides to clients to confirm their holdings, serving as proof of their positions to issuers, primarily for accounts holding beneficial owners' shares, by proving custody positions on a specific date during general meeting registration. LuxCSD issues this message automatically for clients with an active subscription, based on specific priority rules. The relevant date for recording holdings is determined through a hierarchical system, and the certificate of holding is sent on the following business day after the relevant date.

Registration

For German registered shares, a registration is mandatory. The meeting notification will include the "Registration Securities Deadline," indicating when clients must submit their registration instructions.

Clients must either provide the Shareholder ID if available or request registration by setting the "Securities Registration" indicator to true.

Overall, the clients instructing for the German registered securities via LuxCSD may have to consider three deadlines, the Enrolment Deadline, the Securities Registration Deadline and the Vote Deadline as well as the respective market deadline for each.

CBL clients can use the Swift ISO 20022 instruction message or Xact Web Portal for registration requests, which LuxCSD will process by forwarding to the Registrar. The Shareholder ID will be communicated back to clients once available. It's important to note that the registration as a beneficial owner is the only option, and LuxCSD does not validate BO details during registration.

Security registration by the client is only required for general meeting events on CEU-issued registered shares. In other markets, registration is done by the LuxCSD custodian on the basis of the meeting instruction message.

For all share registrations processed out of a meeting instruction, LuxCSD will trigger a deregistration on Securities Registration Market Deadline + 1.

Important Note: LuxCSD will trigger and process the deregistration for the full registered amount processed out of a meeting instruction. In the event that the client has triggered a full or partial deregistration prior to the Securities Registration Market Deadline + 1, the position will not be sufficient to process the deregistration triggered by LuxCSD's general meeting process. In such cases, it will be the LuxCSD client's responsibility to deregister the remaining position.

This page has intentionally been left blank.

7. Communications media

Clients can submit instructions to LuxCSD and receive reports using a variety of communications media.

The communications media available within our suite of Connectivity products are:

- ClearstreamXact; with the following choice of channels:
 - Xact Web Portal;
 - Xact File Transfer;
 - Xact via Swift;
 - Xact via SwiftNet FINplus (also supports Shareholders Identification Disclosure Requests seev.045 and seev.046 in ISO 20022 format).

ClearstreamXact must be used for accounts with settlement in T2S or non T2S eligible securities.

For LuxCSD clients with DCP status it is also possible to send certain instruction types directly to T2S via ISO 20022 messages to receive messages and reports from T2S and to use the T2S GUI to query information, release or put on hold own instructions. A combination of ICP and DCP connectivity channels is possible even for the same transactions, as an instruction sent to T2S is automatically reflected in LuxCSD and vice versa.

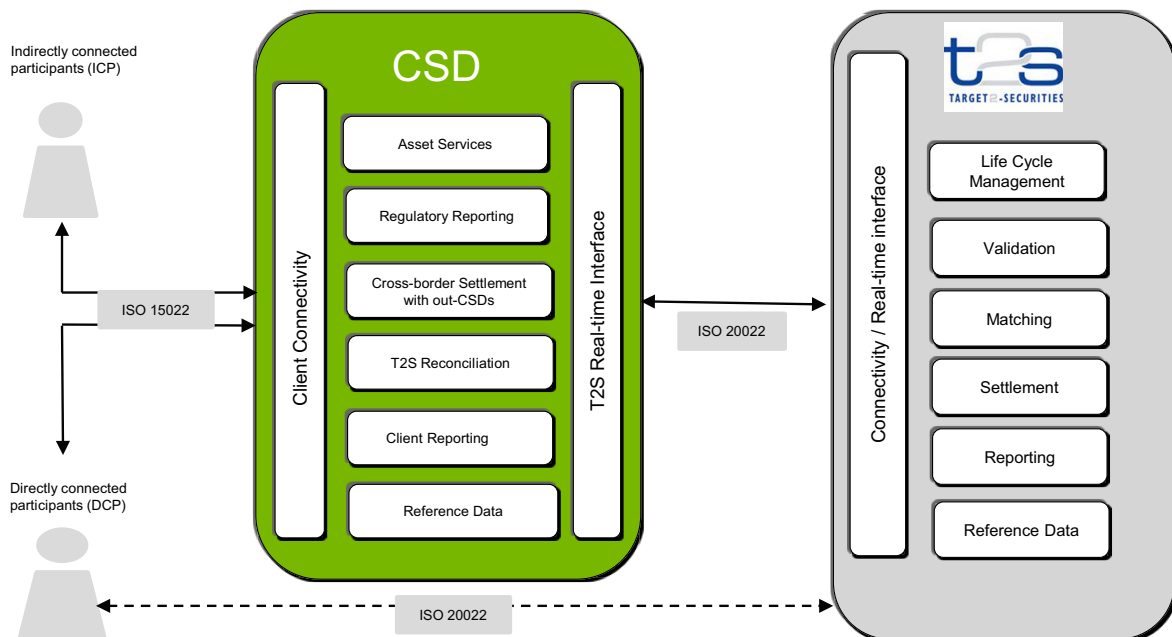

Figure 7-1. Connectivity channels

Exact format specifications and deadlines for instructions are given in the respective Market Guide. The latest versions of the Market Guides are available on the LuxCSD website, under Products & Services / Market Coverage.

The reports sent to clients provide details on the status of instructions, as well as account movements, balances and other information. For further details of report content and the media through which they can be received, please see [Chapter 8](#).

Note: Clients are strongly advised to exercise due care in ensuring and maintaining the security of the communications media by which they submit instructions to LuxCSD or receive reports.

7.1 ClearstreamXact

Xact Web Portal

Xact Web Portal is a web graphical user interface (GUI). The key aspects of Xact Web Portal are:

- New technology enabling clients to use a common graphical user interface (GUI) for more than one service and processing platform. Designed to complement existing ICSD and CSD connectivity channels.
- Consistent look and feel and delivery of services regardless of the legal entity, service or geographical location of LuxCSD clients or their business partners.
- Eventual streamlined user access to our full range of services from a single entry point.
- Dynamic, easily configurable dashboard and context sensitive help.

Access and security

- Accessible from anywhere in the world via internet.
- State of the art security, based on internationally recognised standards to ensure the highest security for clients, whether using a secure public internet connection or virtual private network.
- Single sign on and User Management, fully customisable by the client.

Xact Web Portal Dashboard

The Dashboard provides an overview of a user's activities and provides tools to help the user with their day-to-day activities.

- Interactive landing page after login;
- Easy navigation throughout the system;
- Dashboard panels give you an overview of your current Activities, Tasks or Alerts (profile-dependent);
- Number of outstanding Activities broken into comprehensive segments;
- The Dashboard will become fully customisable as Xact Web Portal expands;
- Go to the Main Menu to reach Services, User Management along with Help and Resources;
- Search the Help and Resource centre.

User Guides

The latest versions of the user guides are available on the LuxCSD website, under Products & Services / Connectivity / ClearstreamXact.

Online queries via Xact Web Portal

Xact Web Portal provides online queries on security transactions, corporate action notifications and proceeds, and positions. It is also possible to query the life cycle of security instructions. Users can query reference data and historical data up to 13 months retrospectively, including the current month.

Users can customise their queries and print or export the results obtained.

Securities queries

The following securities queries are available:

- Instruction status and life cycle up to thirteen months retrospectively, including the current month;
- Securities instructions;
- Securities positions;
- Daily penalties;
- Monthly aggregates;
- Appeals;
- Registered Securities: Beneficial Owner Details;
- Settlement Prediction¹.

Asset servicing queries

The following asset servicing queries are available:

- Corporate action events;
- Corporate action confirmations;
- Corporate action instructions;
- Forecast movements.

Tax queries

The following tax queries are available:

- U.S. Tax;
- Tax refunds;
- Tax certificates;
- FTT query.

Reference Data queries

The following queries on Reference data are available:

1. Settlement Prediction provides clients with a probability prediction that a client instruction will settle by the deadline of the requested settlement date (in the case of pending instructions) or by the deadline of the current business day (for pending failed instructions) (the "Probability Prediction"). The Probability Prediction is calculated by a machine-learned model based on current and historical settlement data. A probability can range from 0.1% to 99.9%. Settlement Prediction also provides clients with an estimate of the cash penalty that a client may need to pay if they are found to be at fault for late settlement (the "Estimated Penalty"). The client expressly acknowledges that the Probability Prediction and Estimated Penalty may be inaccurate for any reason, that the Probability Prediction and Estimated Penalty may not realise and that the Probability Prediction is not to be considered as a guarantee of a particular settlement outcome (that is, will settle or will not settle).

Any decision to take action or not, on the basis of the Probability Prediction and Estimated Penalty, is at the client's sole discretion and risk, and LuxCSD shall make no warranty, no representation and no guarantee as to the accuracy and realisation of the Settlement Prediction or Estimated Penalty. LuxCSD excludes any liability for any damage, liability, loss, cost or expense the client may incur as a direct or indirect consequence of the client's action - or failure to take action - on the basis of the Probability Prediction and Estimated Penalty.

The Probability Prediction and Estimated Penalty are for information purposes only and shall not be construed as any form of advice (legal or otherwise) by LuxCSD.

- Financial instruments;
- Place of safekeeping;
- Currencies;
- Settlement Parties;
- Cash Correspondents.

Help & Resources

- Message Exchange.

Data Analytics

- ActivityNext;
- SettlementNext.

Xact File Transfer

Xact File Transfer is the file transfer solution for bi-directional data transfer. It has been designed for secure straight-through processing that can support high-speed and large instruction volumes. Xact File Transfer can be used for rapid distribution of all reports which are available in Swift ISO 15022 format, extensible mark-up language (XML) format, MS Excel (XLS) and portable data format (PDF).

Xact File Transfer can be linked from any in-house system via the public internet or SwiftNet. Xact File Transfer can be fully integrated with in-house systems and various operating platforms. Xact File Transfer can also be accessed via a standard internet browser on clients' desktops thereby allowing clients to continue working with their current infrastructure. Xact File Transfer can be fully automated, hence requiring no manual intervention, to facilitate straight-through processing.

Xact File Transfer can be used in conjunction with Xact Web Portal for comprehensive instruction input and transaction life cycle monitoring and reporting.

It may also be used as an upload facility for French Financial Transaction Tax (FTT) declaration files.

Instructions sent for same day provisioning are processed immediately upon receipt by the settlement system. Consequently, clients should send prioritised instructions first, to ensure they are processed before any other instructions.

Where clients include two or more instructions for the same security and for same-day provisioning in a single file, priorities and sequences associated to instructions, cannot be assured. In this case, it is recommended to instruct and release the prioritised instruction in a separate file.

Access and security

Xact File Transfer is available via the public internet or via the SwiftNet FileAct service. Overall, this communication infrastructure includes different contingency scenarios in case of network failure and thus provides continuous business and service availability. This network offers clients a flexible and high performance communication solution for the exchange of instructions and reports.

Xact File Transfer is available 24 hours a day, six days per week (not available from 22:00 (CET) on Saturdays until 22:00 on Sundays).

User Guide

Details concerning the usage of Xact File Transfer are published in the Xact File Transfer User Guide.

The latest version of this guide is available on the website, www.clearstream.com under Key Documents / ICSD / Connectivity Manuals.

Xact via Swift

LuxCSD provides full service support via Swift and complies with the latest ISO 15022 standards and SMPG recommendations. Xact via Swift is fully ISO 15022 compliant. It is secure, fully automated and able to provide high-speed, high-volume straight-through system-to-system processing.

Access and security

Swift messages can be addressed to LUXCLULLXXX or to CEDELULLXXX, according to user preference. For LuxCSD outbound messaging, clients can specify LUXCLULLXXX as emitter address in Xact Web Portal.

The Swift message types used for sending instructions are, without exception, authenticated messages. clients using Swift must, therefore, have exchanged authenticator keys with Clearstream to whom LuxCSD has outsourced its operations. Rules governing the exchange of authenticator keys are set out by Swift.

Users can enter instructions for only those accounts that are linked on LuxCSD's files to their Swift address. Users can request LuxCSD to link several of their accounts to one address or, alternatively, they can use multiple addresses to send instructions for the same account. However, LuxCSD must be informed in advance of the exact relationship between accounts and BIC destinations.

Unauthenticated messages cannot be used to send instructions.

Securities settlement instructions

Swift ISO 15022 MT54x message types are used for all securities settlement instructions. All normal Swift syntax rules must be applied. LuxCSD provides validation and informs clients in real time of erroneous or badly formatted messages by sending an MT548 Negative Validation Feedback.

The following messages can be sent:

- MT530 Transaction Processing Command;
- MT540 Receive Free;
- MT541 Receive Against Payment;
- MT542 Deliver Free;
- MT543 Deliver Against Payment.

Securities instructions for asset services

Corporate Action Instruction

User Guide

The Xact via Swift User Guide provides clients with an overview of formats and reports available through the Swift connectivity service.

The latest version of this guide is available on the website, www.clearstream.com under Key Documents / ICSD / Connectivity Manuals.

Cash instructions

Swift message types related to cash instructions, will not be accepted from LuxCSD clients.

Other messages

MT599 message types can be used for free-format authenticated messages to request services or to provide information to LuxCSD.

Reports via Swift

Via Swift, security and other information are contained in separate reports corresponding to specific Swift message categories. Please refer to [Chapter 8](#) for an overview of these reports.

7.2 Communications contingency

LuxCSD provides a suite of communications channels (Xact Web Portal, Xact via Swift and Xact File Transfer).

In case the regular communications channel should become inaccessible or unavailable, clients are recommended to have at least one backup communications channel in place.

In the event that none of the usual available channels of communication can be used, and as a last resort contingency means of communication, instructions can temporarily be accepted or information exchanged via facsimile or email, on condition that a duly signed Letter of Indemnity has been established between the client and LuxCSD for such contingency.

To reduce the risk of failure in processing instructions in the event of such contingency and in order to act with the shortest possible delay, clients are recommended to establish a Letter of Indemnity in advance, specifying that it shall be valid either until revoked (with No transfer period) or until a specified date (with a specified transfer period).

Such Letter of Indemnity, signed by LuxCSD and by the client, shall be valid for all open and new accounts in the name of the client within its country of operation.

For example, a Letter of Indemnity established with a branch of a supranational corporation in one country will not be valid for other branches of the same supranational corporation in other countries.

Clients who want to establish a Letter of Indemnity as described above should contact LuxCSD Client Services or their Relationship Officer (see [Client Services](#) on page 1-4).

Procedure for establishing a Letter of Indemnity

For a contingency situation to be accepted by LuxCSD, the client must agree to comply with the requirements of the following procedure:

- 1 Inform LuxCSD about a presumed contingency situation by contacting LuxCSD Client Services and/or their Relationship Officer via telephone.
- 2 Agree with LuxCSD that there is a contingency situation.
- 3 Inform LuxCSD about the contingency communications medium to be used for the duration of the current contingency situation with the client.
- 4 Inform LuxCSD of the end of the contingency situation as soon as possible via telephone, to confirm that the contingency situation has been resolved.

The above procedure shall be applied by the client every time a contingency situation occurs.

Once the contingency situation is agreed, LuxCSD will verify whether a valid Letter of Indemnity is recorded in its books.

If, on contingency date, no valid Letter of Indemnity is available for the client, LuxCSD will insist that it immediately receives a valid Letter of Indemnity duly signed by authorised persons in the client's institution.

The Letter of Indemnity shall be sent to the client via the appropriate communications medium (facsimile or email) and the client shall return it duly signed to LuxCSD by the same means. The original of the Letter of Indemnity shall also be delivered promptly to LuxCSD via postal mail.

Based on LuxCSD's internal validation of the client signatures, the process of inputting manual instructions on behalf of the client can begin.

On request and depending on the client's needs, LuxCSD Client Services will provide the client with different templates for their cash and/or settlement instructions.

Only valid and complete instructions containing the necessary level of information detail will be processed.

Note: LuxCSD will always act on a "best efforts" basis and shall not be held responsible for any delay or any loss, damage, expense that might occur with regard to any manually handling instructions, unless such is due to LuxCSD's gross negligence or wilful misconduct.

The manual setup of client contingency instructions is subject to fees as per the LuxCSD Fee Schedule.

7.3 IT releases

LuxCSD may, at its sole discretion, issue from time to time IT releases to update the Connectivity products listed above ("Release"). However, LuxCSD shall notify the client on any Release in advance ("Release Notes").

The client undertakes:

- i) to implement such Releases without undue delay;
- ii) to test Releases, in accordance with paragraph (3) below, sufficiently in advance without any finding of defects or errors; and
- iii) that any third party software used by the client in connection with the Connectivity products listed below ("Participant Software") is fully compatible therewith and interacts with the LuxCSD systems without any error or interruption; such Participant Software shall be sufficiently tested by the client prior to its first use.

Whenever LuxCSD provides for a simulation and testing phase with respect to a Release ("Simulation"), the client shall participate in such Simulation, provided that participating in such Simulation is specified as "mandatory" for the client in the Release Notes. In case the participation in the Simulation is not specified as mandatory for the client, the client may also participate in the Simulation. If any error or malfunction of the LuxCSD systems occurs during the Simulation, the client shall inform LuxCSD about such error or malfunction without undue delay.

The client shall provide LuxCSD, prior to the first use of the LuxCSD system after a Release had been implemented, with a written statement confirming to LuxCSD that (i) the updated LuxCSD system successfully passed internal test procedures, and (ii) the Participant Software interacts with the updated LuxCSD system without any errors or interruptions ("Readiness Statement").

If a Release also requires an adaptation, update or amendment of the Participant Software, the client shall (i) adapt, update, or amend its Participant Software accordingly to ensure that the Participant Software interacts with the LuxCSD system without any error or interruption, and (ii) sufficiently test the functioning of the Participant Software prior to the first use.

A declaration by the client stating that the LuxCSD system interacts with the Participant Software without any errors or malfunctions after the implementation of the Release shall be deemed to have been made, if the client (i) either commences with the use of the LuxCSD system after the implementation of the Release, or (ii) fails, within a period of 15 business days after the implementation of the Release, to inform LuxCSD about the occurrence of any errors or malfunctions with respect to the interaction of the Participant Software with the LuxCSD system. LuxCSD shall expressly draw the client's attention to such legal consequence in the Release Notes.

In case LuxCSD systems, including Releases, are not working properly, the client shall use any workaround provided by LuxCSD. LuxCSD is entitled to implement Releases also without consent of the client, provided that LuxCSD informs the client of such Releases sufficiently in advance.

This page has intentionally been left blank.

8. Reports and information services

This chapter provides an overview of the reports available via the different communications media currently supported by LuxCSD and it gives an outline of the information available in each type of report. Technical information appropriate to each medium, and fuller descriptions of the reports together with examples, are given in the user manuals for each communications medium.

Unless advised otherwise within 30 days, LuxCSD considers the information indicated in client reports to be accepted and approved by the client.

8.1 Choice of reports

Clients can choose from the range of reports available via the connectivity channels described within this chapter. Reporting profiles can be set up that are tailored to their own business requirements. For these profiles, clients are asked to specify which reports¹ they want to receive/retrieve, and via which communications media. They can do this via Xact Web Portal Reporting Centre where they specify the delivery channel, format, frequency and time of the reports they want to receive. Alternatively, clients can send a Swift MT599 (see [Monthly billing reports](#) on page 8-11) or a subscription form signed by authorised signatories for the attention of the LuxCSD/PRGconnect department.

Tailored reporting profiles can be set up to meet clients business requirements. Clients can also select to receive/retrieve versions of reports according to the frequency with which updated information on transaction status and positions is needed.

8.2 Reconciliation

LuxCSD maintains the appropriate reconciliation procedures to ensure the integrity of the securities held in LuxCSD's system in order to comply with the obligations set out in Article 37 of the CSDR as well as Articles 59 to 65 and Article 86(1)(a) of Commission Delegated Regulation EU No 2017/392 (ESMA RTS).

Daily Statements and daily reconciliation

Accordingly and in order to enable clients to comply with their obligations to reconcile their records on a daily basis as set out in the Article 46 of the GTCs and Article 64(3) ESMA RTS, clients are provided with the following necessary information specified for each client account and each securities issue, on a daily basis:

- The aggregate balance of each securities account at the beginning of the respective business day;
- The individual securities transfers in or from a securities account during the respective business day; and
- The aggregate balance of a securities account at the end of the respective business day.

Important Note: Clients shall retrieve the above mentioned information by using existing information channels such as Xact Web Portal, File Transfer, Xact via Swift MT535/MT536.

1. There is no default reporting for Clearing and Settlement reports. However, in the absence of, or in cases of incomplete account opening form, a default subscription for Income and Corporate Action reporting will be created at new account creation.

Reconciliation breaks

If a reconciliation inconsistency or mismatch (referred to as a "break") is detected by the client, then they must inform LuxCSD promptly and report it via the Client Service channels.

The client shall provide LuxCSD with the information that LuxCSD deems necessary to ensure the integrity of the securities issue and to enable it to solve any reconciliation breaks in accordance with Chapter IX of the ESMA RTS. Where needed, the investigation efforts during reconciliation procedures may imply cooperation and information exchange with third parties involved in the reconciliation process with LuxCSD. Clients hereby acknowledge and authorise that, according to Article 64(4) of ESMA RTS, LuxCSD may provide the information referred to above at the request of other holders of accounts with LuxCSD, to the sole extent that information is necessary for the reconciliation of those holders' records with the records of LuxCSD.

As a reconciliation resolution measure, LuxCSD may reverse any credit or debit of securities made to the client as a result of a break, regardless whether the break is due to LuxCSD, the client, another client or any other person.

Important Note: The client shall not attempt to take any action to adjust the entry on its own without having informed LuxCSD beforehand. LuxCSD shall not be held liable of any losses or damages caused by such direct action of the client (such as, without being limited to, a direct instruction to a register agent, an issuer agent or a transfer agent or broker outside LuxCSD's system). In such a situation, the client shall hold LuxCSD harmless for any damages, losses, costs (including reasonable fees of counsel), expenses or penalties incurred as a result of its action.

To prevent or solve a break detected and to comply with its obligations of reconciliation in accordance with CSDR, LuxCSD may in addition take any other actions that LuxCSD deems necessary to achieve such purpose. LuxCSD informs the client without undue delay of such measures.

As a result of the corrective reversal, the client is solely responsible for covering any shortfall in the relevant account. If they fail to do so, such shortfall will be considered as a securities loss under Article 9 of the GTCs and such loss may be shared with other clients holding the relevant securities with LuxCSD. LuxCSD shall not be liable for the application of such loss sharing provision in accordance with the General Terms and Conditions.

Suspension of Settlement

Where the above mentioned breaks reveal an undue creation or deletion of securities, and the CSD fails to solve such problem by the end of the following business day, LuxCSD is obliged to suspend the securities issue for settlement until the undue creation or deletion of securities has been remedied.

The suspension of settlement of a security can be decided by another CSD in accordance with CSDR. Upon receipt by LuxCSD of the notification of a suspension of settlement of a securities issue by another CSD, LuxCSD shall subsequently suspend, in its capacity as investor CSD directly or indirectly linked to this CSD (including in for interoperable links, such as the Bridge), this security issue from settlement.

In such a situation, CSD shall inform clients without undue delay and any other relevant market infrastructure having access to LuxCSD (for example, CCP and stock exchange) of the suspension of the settlement in the relevant securities issue. The same applies when settlement has been resumed, following the resolution of an undue creation or deletion of securities.

LuxCSD informs clients through the usual communication channels, via specific publications on its website and banners in the online connectivity channels (Xact Web Portal).

Note: Clients shall ensure that connectivity is set up to receive the operational news alerts without delay.

For suspension of settlement, the process is the following:

- LuxCSD keeps the existing and valid Instructions in the settlement system. The instructions will show the last status available prior to the suspension. Settlement resumes once the suspension of settlement has been lifted.

- New instructions are accepted and are eligible for matching but will not be proposed for settlement. Settlement will only take place once the suspension of settlement has been lifted.
- Processing of ongoing corporate action events (referring to both income and corporate action events) where the event basis security is blocked due to an undue creation or deletion of securities will be suspended. LuxCSD informs clients about the suspension of a corporate action event via Corporate Action Notification with a specific narrative. The same applies when the corporate action event is resumed. The status is also visible in Xact Web Portal.

Note: Instructions to participate in voluntary and mandatory with choice events, where the event basis security is blocked due to an unresolved undue creation or deletion of securities, will continue to be accepted by LuxCSD and transmitted to depositories/agents. The processing of the resulting proceeds is however suspended until the undue creation or deletion of securities has been remedied.

The Corporate Action Notification as of payment date + 1 business day shows the earliest payment date as "unknown" if payment is suspended.

Since the payment processing is only resumed once the break is solved, the crediting of proceeds and sending of MT566 confirmation message may be delayed.

8.3 Connectivity channels

Reports and online queries

The information available via the connectivity channels can be broadly grouped into:

- Clearing and settlement reports;
- Asset Servicing reports;
- Miscellaneous reports;
- Online queries via Xact Web Portal.

Clearing and settlement reports

Clearing and settlement reports are shown in the following figure:

Report	Description
Intra-Position Advice (MT508)	Reports movements between sub-balances linked to blocking/unblocking activity.
Statement of Holdings (MT535)	Reports the holdings that LuxCSD services for the client. The complete report contains all holding information. The Delta report contains only changes since the previously sent statement.
Statement of Transactions (MT536)	Reports settled transactions impacting the client's aggregate and/or sub-balances.
Statement of Pending Transactions (MT537)	Reports transactions that are not yet booked because they have either a forthcoming requested settlement date or have failed to settle. All statuses or the most relevant status can be reported.
Statement of Intra-Position Advice (MT538)	Reports movements between sub-balances linked to blocking/unblocking activity.
Settlement Confirmations (MT54x)	MT544, MT545, MT546 and MT547 Settlement Confirmations all receive and deliver securities transactions, free of and against payment, that have settled on the date of the report.
Settlement Status and Processing Advice (MT548)	Reports the rejection or pending status(es) of a previously received instruction or cancellation request.
Settlement Allegement (MT578)	Reports (single item) urgent allegements from LuxCSD and Clearstream participants and selected markets.
Statement of Settlement Allegements (MT586)	Reports intra-CSD and cross-CSD allegements.
Statement of Repaired Transactions	Shows detailed information from Clearstream's depositories, identifying repaired Instructions with the reason for repair.
T2S Dedicated Cash Account Statement (MT940)	Reports all cash movements (settlement and custody) of the T2S Dedicated Cash Account (DCA) including securities movements of the T2S Securities Accounts (SACs) linked to any of the Central Securities Depositories (CSDs).

Figure 8-1. Clearing and settlement reports

Availability of clearing and settlement reports and online queries

8. Reports and information services

The following figure summarises clearing and settlement reports and their availability and shows if the equivalent information can be queried using Xact Web Portal. The report formats available via Xact File Transfer are also shown.

Note: The times indicated for report availability are approximate and may be subject to delays in processing beyond LuxCSD's reasonable control. LuxCSD does not accept any liability for such delays. Intraday reports are available throughout the day, however the cutoff time for LuxCSD is 18:00.

Report	Available	Xact via Swift	Xact Web Portal	Xact File Transfer
MT508 Intra-Position Advice	Intraday: 19:00; 21:15; 23:00; 00:00;01:00; 02:00; 03:00; 04:00; 05:00; 06:30; 07:30, 08:30; 09:30; 10:30; 11:30; 12:00; 13:00; 13:30; 14:30; 15:30; 16:00; 16:30; 17:00; 18:00 Format: this report is only available in ISO format.	ISO	ISO Queries	ISO
MT535 Statement of Holdings	Intraday: 01:00, 02:00; 03:00, 04:00; 05:00; 06:30; 07:30, 08:30; 09:30; 10:30; 11:30; 12:00; 13:00; 13:30, 14:30; 15:30; 16:00; 16:30; 17:00; 18:00; 19:00; 21:15 ^a ; 23:00; 00:00 Daily: 21:15; Weekly: 21:15 Monthly: 21:15; Quarterly: 21:15; Yearly: 21:15	ISO	HTML ISO PDF XLS XML Queries	ISO PDF XLS XML
MT536 Statement of Transactions	Intraday: 19:00; 21:15 ^b ; 23:00; 00:00; 01:00; 02:00; 03:00; 04:00; 05:00; 06:30; 07:30, 08:30; 09:30; 10:30; 11:30; 12:00; 12:30; 13:00; 13:30, 14:30; 15:30; 16:00; 16:30; 17:00; 18:00 Daily: 18:00; Weekly: 18:00; Monthly: 18:00	ISO	HTML ISO PDF XLS XML Queries	ISO PDF XLS XML
MT537 Statement of Pending Transactions	Intraday: 01:00; 02:00; 03:00; 04:00; 05:00, 06:30; 07:30, 08:30; 09:30; 10:30; 11:30; 12:00; 12:30; 13:00; 13:30, 14:30; 15:30; 16:00; 16:30; 17:00; 18:00; 19:00; 21:15 ^a ; 21:30; 23:00; 00:00 Daily: 18:00; Weekly: 18:00; Monthly: 18:00 Continuous: every 15 minutes	ISO	ISO PDF XLS XML Queries	ISO PDF XLS XML
MT538 Statement of Intra-Position Advice	Intraday: 19:00; 21:15 ^b ; 21:30; 00:00; 01:00; 02:00; 03:00; 04:00; 05:00, 06:30; 07:30, 08:30; 09:30; 10:30; 11:30; 12:00; 12:30; 13:00; 13:30, 14:30; 15:30; 16:00; 16:30; 17:00; 18:00 Daily: 18:00; Weekly: 18:00; Monthly: 18:00	ISO	ISO PDF XLS XML Queries	ISO PDF XLS XML
MT54x Settlement Confirmations	Via Swift:Real-time Via Xact File Transfer: Intraday: 19:00; 21:15; 23:00; 00:00;01:00; 02:00; 03:00; 04:00; 05:00; 06:30; 07:30, 08:30; 09:30; 10:30; 11:30; 12:30; 13:00; 13:30, 14:30; 15:30; 16:00; 16:30; 17:00; 18:00 Continuous: every 15-20 minutes	ISO	ISO Queries	ISO
MT548 Settlement Status and Processing Advice	Via Swift: Real-time Via Xact File Transfer Intraday: 19:00; 21:15; 23:00; 00:00; 01:00; 02:00; 03:00; 04:00; 05:00, 06:30; 07:30, 08:30; 09:30; 10:30; 11:30; 12:30; 13:00; 13:30, 14:30; 15:30; 16:00; 16:30; 17:00; 18:00 Continuous: every 15-20 minutes	ISO	ISO Queries	ISO

Report	Available	Xact via Swift	Xact Web Portal	Xact File Transfer
MT578 Settlement Allegement	Via Swift: Real-time Via Xact File Transfer Intraday: 19:00; 21:15; 21:30; 23:00; 00:00; 01:00; 02:00; 03:00; 04:00; 05:00, 06:30; 07:30, 08:30; 09:30; 10:30; 11:30; 12:30; 13:00; 13:30, 14:30; 15:30; 16:00; 16:30; 17:00; 18:00;	ISO	ISO Queries	ISO
MT586 Statement of Settlement Allegements	Intraday: 19:00; 21:15 ^a ; 21:30; 23:00; 00:00; 01:00; 02:00; 03:00; 04:00; 05:00, 06:30; 07:30, 08:30; 09:30; 10:30; 11:30; 12:30; 13:00; 13:30, 14:30; 15:30; 16:00; 16:30; 17:00; 18:00 Daily: 18:00; Weekly: 18:00; Monthly: 18:00 Continuous: every 15 minutes	ISO	ISO PDF XLS XML Queries	ISO PDF XLS XML
Statement of Repaired Transactions	Weekly: 21:15; Monthly: 21:15		PDF XLS XML	PDF XLS XML
MT940 T2S Dedicated Cash Account Statement	The report can be generated either at fixed time, or upon the occurrence of a T2S event (please refer to the respective subscription form available on the Central Bank website for further details)	ISO		

-
- a. the 21:15 report in Complete or Delta form is a mandatory by default report independent of any other report scheduled Intraday.
 - b.the 21:15 report in Delta only form is a mandatory by default report independent of any other report scheduled Intraday.

Figure 8-2. Clearing and settlement reports and their availability

Asset Servicing reports

Asset Servicing reports are shown in the following figure.

Report	Description
Corporate Action Notifications	Reports corporate action event details along with the possible elections or choices available to the client. It can initially be sent as a preliminary advice and subsequently replaced by another MT564 with complete/confirmed information.
Urgent Uninstructed Notifications	Provides a regularly updated breakdown of instructed and uninstructed securities balances related to corporate action and tax breakdowns.
Income Pre-Advice Report - IPAR	The MT564 Income Pre-Advice Report provides a forecast on cash and securities proceeds over the five Business Days following the day the report is sent. For income and corporate action proceeds, this report must be subscribed to from, and reports from, the LuxCSD safekeeping account.
Claim and Reversal Advice - CRA	The MT564 Claims and Reversal Advice reports detected market claims and reverse market claims subject to compensation by LuxCSD, as well as the reversal of compensated market claims or reverse market claims and of paid income or non-income events.
Corporate Action Confirmation	Reports proceeds from income and redemption events and corporate action events credited to a client's account.
Corporate Action Status and Processing Advice	Indicates whether a corporate action instruction or cancellation is accepted for processing, rejected or denied. It is also sent to clients whose corporate action instruction is pending due to insufficient holding.
US Withholding Tax Report (MT568)	Reports, on a monthly basis, U.S. taxable income events, including withholding tax rates applied per beneficial owner.
Market Claims Report	The Market Claims Report provides a complete overview by account of potential market claims that are created when the actual Settlement of a security trade takes place after the entitlement date of an associated income or non-income distribution. In addition, the report offers information about LuxCSD's compensation activities for market claims by providing the current processing status of a claim, together with a related reason code, throughout its lifecycle.
Tax Credit Report	When a bulk tax credit is generated at the end of the day, the system generates a Tax Credit Report that provides a list of market claims considered by the system for the computation of the bulk tax credit.
The Corporate Action Reference Data Report	Provides detailed information about corporate actions for any security held in LuxCSD, even if clients do not hold the underlying securities. Clients must submit a list of financial instruments via Xact File Transfer via Internet and receive a report with all Corporate Action Notifications associated with the securities. The report will be sent to their Xact File Transfer FileStore or can be downloaded via Xact Web Portal.

Report	Description
Terms and Conditions	<p>Clients can download Terms and Conditions from Xact Web Portal by querying first on the Financial Instrument via the Reference Data module.</p> <p>If the documents are available in the database, delivery will be within several minutes through Xact File Transfer via Internet.</p> <p>The documents requested by the client will be sent to a dedicated folder, named "Terms and Conditions", in the Xact File Transfer FileStore. Published documents are electronic copies of the latest versions of prospectuses, other definitive documents for stand-alone securities, or pricing supplements for programme-linked securities.</p>
Shareholder Identification Request	<p>The Shareholder Identification Disclosure Request is driven by the respective issuer and asks all intermediaries in the custody chain to disclose (send to the response recipient defined in the request) its holdings for a specific ISIN.</p> <p>The Shareholder Identification Disclosure Request Cancellation Advice serves to communicate the cancellation of a Shareholder Identification Disclosure Request to the custody chain.</p>

Figure 8-3. Asset Servicing reports

Availability of Asset Servicing reports and online queries

The following figure summarises Asset Servicing reports and their availability and shows if the equivalent information can be queried using Xact Web Portal. The report formats available via Xact File Transfer are also shown.

Note: The times indicated for report availability are approximate and may be subject to delays in processing beyond LuxCSD's reasonable control. LuxCSD does not accept any liability for such delays.

Report	Available	Xact via Swift	Xact Web Portal	Xact File Transfer
Corporate Action Notifications	Via Swift: Real-time (Delta) Continuous (Delta) every 15 minutes via Xact File Transfer	ISO	ISO PDF XLS XML Queries	ISO PDF XLS XML
Urgent Uninstructed Notifications Report	Intraday: 06:00; 10:00; 12:00; 14:00; 16:00; 18:00; 21:30		PDF XML Queries	PDF XML
Income Pre-Advice Report (IPAR)	Via Swift: Real-time (Delta) Intraday (complete): 03:00; 08:00; 21:30; 22:30 Continuous (Delta) when available via Xact File Transfer	ISO	ISO PDF XLS XML Queries	ISO PDF XLS XML
Claim and Reversal Advice	Via Swift Real-time (Delta) Continuous (Delta) every 15 minutes via Xact File Transfer	ISO	ISO PDF XLS XML Queries	ISO PDF XLS XML
Corporate Action Confirmation	Via Swift Real-time (Delta) Continuous (Delta) every 15 minutes via Xact File Transfer	ISO	ISO PDF XLS XML Queries	ISO PDF XLS XML
Corporate Action Status and Processing Advice	Via Swift Real-time (Delta)	ISO	ISO Queries	
MT568 Corporate Action Narrative	Via Swift Real-time (Delta) Intraday: 03:00; 08:00; 21:30; 22:30 Continuous (Delta) every 30 minutes via Xact File Transfer	ISO	ISO PDF XLS XML Queries	ISO PDF XLS XML
Holdings Distribution by Market	Daily: 21:15; Weekly: 21:15 Monthly: 21:15		PDF XML	PDF XML
Market Claims Report	Daily: 22:30		PDF XML	PDF XML
Corporate Actions Reference Data Report	Intraday: 06:00; 21:30		ISO PDF XLS XML Queries	ISO PDF XLS XML
Shareholder Identification	Via Swift: Real-time	ISO	Queries	XML

Figure 8-4. Asset Servicing reports and their availability

Free-format message reports

Report	Description
MT568 Corporate Action narrative	Manually generated free format messages sent by LuxCSD about any topic.
MT599 Free-format report	Manually generated free format messages sent by LuxCSD about any topic.

Figure 8-5. Free-format message reports

Availability of reports

The following figure summarises the free-format message reports and their availability.

Note: The times that are indicated for report availability are approximate and may be subject to delays in processing that are beyond LuxCSD's reasonable control. LuxCSD does not accept any liability for such delays.

Report	Available at	Xact via Swift	Xact Web Portal	Xact File Transfer
MT568 Corporate Action narrative	Via Swift: Real-time Continuous every 15 minutes via Xact Web Portal and Xact File Transfer	ISO	ISO	ISO
MT599 Free-format report	Via Swift: Real-time Continuous every 15 minutes via Xact Web Portal and Xact File Transfer	ISO	ISO	ISO

Figure 8-6. Free-format message reports and their availability

8.4 Monthly billing reports

Fees and charges levied by LuxCSD for its services are given in the LuxCSD Fee Schedule, which is available on the website, www.luxcsd.com.

Statement of Fees

This monthly advice provides a breakdown of individual fees, divided into the following categories:

Safekeeping, CeBM Funding service, Custody administration, Information provision, Miscellaneous fees and Additional external charges.

In addition, a separate summary of out of pocket expenses debited throughout the month is sent, easing the reconciliation of these charges and the related Value Added Tax (VAT), when applicable.

8.5 Client documentation

A wide range of technical documentation describing LuxCSD's products and services is published, including Announcements, the Market Guide and the Codelist.

New and replacement pages are published for the Market Guide whenever a new link is launched or changes occur in a domestic market, sometimes together with an Announcement summarising the developments.

For further details about client documentation, see [Sources of information for clients](#) on page 1-10.

To request further copies of any LuxCSD documentation, or to amend your mailing details in any way, please contact your Relationship Officer.

8.6 T2S Dedicated Cash Account Statement (MT940)

When offered by a Central Bank, holders of a T2S Dedicated Cash Account (DCA) can subscribe to the T2S Dedicated Cash Account Statement (MT940). This statement is the conversion of the T2S message “camt.053 – Statement of Account” into ISO 15022 format. The client acknowledges that this service reports all DCA cash movements (settlement and custody) including the cash leg of securities movements in and out of the T2S Securities Accounts (SACs) linked to any of the Central Securities Depositories (CSDs).

The T2S Dedicated Cash Account Statement (MT940) includes:

- The start of day balance;
- The end of day balance;
- Information on booked entries;
- Underlying details of transactions; and
- Cash available on the T2S DCA.

The MT940 T2S Dedicated Cash Account Statement does not constitute part of LuxCSD’s books but represents the official statement from T2S and Central Banks and will be sent to clients from the BIC address CEDELULLXXX or LUXCLULLXXX (depending on the client’s preference).

LuxCSD accepts no responsibility or liability beyond the correct conversion of the report into the ISO 15022 format, provided the statement is received from T2S.

A LuxCSD client holding a T2S DCA at a Central Bank offering the service and that wishes to receive the T2S Dedicated Cash Account Statement (MT940) must subscribe to the “camt.053 – Statement of Account” (Swift ISO 20022 format) through their Central Bank that will then apply for the message on behalf of its client in T2S.

Only then can the LuxCSD client subscribe to the service by sending a free-format message (Swift MTx99 or Xact Web Portal) to CEDELULLXXX or LUXCLULLXXX for the attention of “PRGconnect - for the T2S Dedicated Cash Account Statement (MT940)” indicating:

- LuxCSD account for billing purposes;
- BIC address;
- DCA number;
- Start date.

The client can use an existing LuxCSD account or open a new one and is required to provide a payment BIC address.

Through this set-up, LuxCSD automatically receives the “camt.053 – Statement of Account” on behalf of its client. LuxCSD handles the mapping of the camt.053 message into the MT940, the distribution of the statement to the respective clients and the billing of the statement to the LuxCSD account.

8.7 Billing Portal

The LuxCSD Billing Portal provides easy online access to client's invoices.

Once an invoice has been dispatched by mail it can be accessed directly via the Billing Portal, thus enabling clients to review their invoices at an earlier date. In addition, all invoices can be downloaded from the Billing Portal in PDF and XML format and are continually updated to reflect the payment status. Details on how to register for this service can be found on the website.

This page has intentionally been left blank.

Glossary

This Glossary is intended for information purposes only and is designed to help clients to understand the terminology used by LuxCSD in this Handbook. In some cases, the way in which the terms are used in LuxCSD may differ from how the terms may be applied in another context. The descriptions given are not to be considered as legally binding definitions of the terminology used.

A

Appeal

“Appeals” refer to the exceptional correction or update of previously calculated and reported settlement fails penalties upon client request.

Authenticated Message

A communication that is sent by mail in writing and signed by an Authorised Person(s), a communication that is as attachment to an email and signed electronically by Authorised Person(s) or that is sent via Swift. It also includes any other secured communication media the use of which is agreed in writing by LuxCSD and the client.

Authorised Person

With respect to the client, any such person duly authorised by such the client to give instructions or notices on the client’s behalf, such persons and their specimen signatures to be provided by the client from time to time to LuxCSD.

B

Balance

The segregated holding, in either securities or cash, within the overall position held in an account resulting from the **settlement of transactions**.

Book-entry

A method whereby transfer of ownership of securities is effected by debits and credits to accounts without the need for the movement of physical **certificates** or documents.

Business Day

Unless otherwise specified, a day on which LuxCSD is open for business.

C

Calculating-CSD

CSD subject to CSDR where the actual settlement (fail) is taking place.

The Calculating-CSD calculates, reports and collects/distributes penalties to its clients (that may as well be CSDs); also in cross-CSD settlement fails scenarios involving direct links, to avoid duplication of penalties calculation and reconciliation issues between linked CSDs, penalties are exclusively to be calculated by the Calculating-CSD.

CEU

See **Clearstream Europe AG**.

CBL

See **Clearstream Banking S.A. Luxembourg**.

CCP

Central counterparty.

CeBM

Central Bank Money.

Central Counterparty

An entity that interposes itself, in one or more markets, between the counterparties to the contracts traded, becoming the buyer to every seller and the seller to every buyer and thereby guaranteeing the performance of open contracts.

CFI

Classification of Financial Instruments Codes (ISO-Norm 10962:2015)

Clearance/Clearing

In the context of LuxCSD, **Clearing** means the entire processing of a **Transaction**, from receipt of the **instruction**, through **Matching** and the various status levels in Suspense, to final **settlement** and accounting. The final **Clearance** of the **Transaction** is the process of determining accountability for the exchange of cash and securities between the **counterparties** to a trade; Clearance leads to new book-entry **Balances** and positions in securities and/or funds.

Clearstream Europe AG (CEU)

Formerly Deutsche Börse Clearing, from 1 January 2000 a subsidiary company of Clearstream Holding AG. Located in Frankfurt, it handles the **settlement** of foreign securities on behalf of its German **clients** and the **settlement** of German securities traded between its German **clients** and counterparties with accounts in external **Clearing** systems such as CBL.

Clearstream Banking S.A. (CBL)

Effective 1 January 2000, Cedel merged with Deutsche Börse Clearing to form the new entity of Clearstream International, jointly owned by Cedel International and Deutsche Börse AG. Clearstream Banking Luxembourg (CBL) is a subsidiary of Clearstream Holding AG and carries out the traditional business of the former Cedel- **Clearing, settlement** and custody. Other subsidiaries include Clearstream Europe (CEU) and Clearstream Services.

Client

A legal person or entity, whether public or private, that has been accepted by LuxCSD as a client.

Closing

The process in which securities are first authenticated and released by the **Issuer**, the legal documentation is finalised and the securities are released for distribution.

Closing Date

The date on which the **Closing** occurs.

Communications User Manuals

Documents that set out the procedures, options and formats to be followed by **clients** according to the method of communication used. Communications User Manuals are Governing Documents if designated as such by LuxCSD upon publication.

Counterparty

One party to a trade or **transaction**. A trade takes place between two **counterparties**. Usually one party to a trade refers to its trading partner as the counterparty.

Countervalue

The cash amount to be received in return for a specified delivery of securities.

Coupon

Detachable **certificate** attached to a security allowing the holder to collect interest or **dividends** payable on a specified coupon payment date upon presentation of the detachable **certificate** to a **Paying Agent**. In the case of fixed rate instruments, the coupon shows the amount of interest payable.

Creation Platform

CBL's central settlement platform for clearing and settlement that LuxCSD uses for the settlement of LuxCSD eligible transactions outside T2S.

Cross-CSD settlement

Settlement between two clients located in different CSDs.

CSDR

Regulation (EU) No 909/2014 of the European Parliament and of the Council of 23 July 2014 on improving securities settlement in the European Union and on central securities depositories. Full text available [here](#).

Currency Code

The three-letter ISO code used by LuxCSD to identify a specific currency.

D

DCP

In the context of T2S, acronym standing for Directly Connected Participant.

Deadline

Latest time for submission of **instructions** for inclusion in the processing for the **Requested settlement Date**. All deadlines quoted in hours and minutes (hh:mm) should be understood to include “:00” seconds. For example, 16:00 should be understood to mean 16:00:00.

Debt Securities

Securities created through and evidencing a loan by the **Issuer**, such as, for example, Commercial Paper, notes, Certificates of Deposit, **Medium-Term Notes**, and bonds, but excluding **Warrants** and **Equities**.

Definitive securities

Individualised physical securities as opposed to book-entry securities.

Delivery Against Payment / Delivery Versus Payment

The irrevocable exchange of securities (the delivery) and cash value (the payment) to settle a **transaction**. True Delivery Against Payment involves the simultaneous exchange of securities and cash.

Delivery Free of Payment

A **Transaction** for the irrevocable delivery of securities from a LuxCSD account without an associated payment of funds.

Dematerialisation

The elimination of physical Certificates or documents of title.

Depository Receipt

Certificate issued, within a domestic market, that represents a holding, usually within another domestic market, in the original securities. Examples:

- ADR - American Depository Receipt
- BDR - Bearer Depository Receipt
- CDR - Continental Depository Receipt
- EDR - European Depository Receipt
- IDR - International Depository Receipt

Dividend

Allocation of a portion of company profit to shareholders. Dividends are paid pro rata to the number of shares held and are normally paid in cash, although they may also be paid in the form of shares (stock Dividend).

Domestic counterparty

A counterparty that has contracted with a LuxCSD **client** to settle an external instruction outside LuxCSD. See **External instruction**.

Drawing

The process of allocating specific **Certificate** numbers to be redeemed at a pre-agreed price in a partial **Redemption** of an issue of securities, in accordance with the terms and conditions of an issue.

DVP

Abbreviation for Delivery Versus Payment. See **Delivery Against Payment**.

E

ECB

European Central Bank

Effectuation

The act of physically signing the **Certificate** representing the security, executed on the basis of an Effectuation authorisation and Effectuation **instruction** received from the **Issuer** or the **Issuing Agent**.

ESMA

European Securities and Markets Authority.

ETF

Exchange Traded Fund

Ex-Date

The date on which shares are traded without corporate action entitlement; for example, **Dividend**, purchase right etc.

External-CSD settlement

Settlement between a LuxCSD client and a client located in a domestic CSD.

External instruction

An instruction with a counterparty in a domestic market outside T2S, supported using a LuxCSD direct link.

F

Fail/Failed Transaction

A securities **Transaction** that fails to settle, either at all or on time.

FIRDS

Financial Instrument Reference Data System.

ESMA Database of instruments reference data collected under MAR Article 4 and MiFIR Article 27.

Fiscal Agent

A financial institution appointed by the **Issuer** as its **Issuing Agent** for the issue when no trustee has been appointed. Its functions include those of the **Principal Paying Agent** as well as some other administrative functions, but none of the fiduciary responsibilities of a trustee.

FITRS

Financial Instruments Transparency System.

ESMA Database of equity and non-equity transparency calculation results.

Flexible

The criteria used in the **settlement Sequence Options** chosen by the **client** can be **Strict** or Flexible. If the criteria are Flexible, the first **Transaction** in the **Transaction Queue** is considered first, but, if it does not settle, then **Transactions** in the same security that are further down the queue will be considered for **settlement**.

Floating Rate Note (FRN)

A bond for which the **Coupon** interest rate is not fixed for the life of the issue. The terms and conditions of the issue can take many different forms. Usually, the **Coupon** is payable semi-annually. The **Coupon** rate on FRNs is generally fixed on predetermined dates in advance of the **Coupon** period in line with changes in market interest rates, often as evidenced by reference to indicators such as LIBOR, LIBID, etc. Mismatch FRNs have a **Coupon** that is re-fixed at more frequent intervals than the **Coupon** interest payment. Capped and mini-max FRNs set maximum, or minimum and maximum, **Coupon** interest rates. Drop-lock FRNs become fixed rate if the method of calculation of the floating rate determines that the **Coupon** interest rate falls below a minimum level. Convertible FRNs carry the option of conversion into fixed rate instruments.

FNTC

T2S First Night Time Cycle.

Free of Payment

A transfer of securities without an associated transfer of funds.

FRN

See **Floating Rate Note**.

Fungible

In LuxCSD, a Fungible **Balance** represents a **Nominal Amount** of securities from a pool of interchangeable securities of the same **Security Code**.

G

Governing Documents

The **General Terms and Conditions, Client Handbook** and **Communications User Manuals**, which may be amended from time to time, and such other documents as LuxCSD may, from time to time, so designate. The Governing Documents describe the overall contractual relations between LuxCSD and its **clients**.

GNA

Global net amount; refers to the actual monthly debit or credit amount of cash penalties reported by LuxCSD to its clients (per counterparty-CSD and per penalties currency). LuxCSD will collect or distribute each "Global Net Amount" once a month, on the 18th PBD of the following calendar month.

I

ICMA

International Capital Market Association (created in July 2005 by the merger of the International Securities Market Association (ISMA) and the International Primary Market Association (IPMA)) is an organisation with a broad franchise across the primary and secondary international capital market. This association has the mandate and the means to represent the interests of the investment banking industry in maintaining and developing an efficient and cost effective international market for capital.

ICP

Indirectly Connected Participant in T2S.

Immobilisation

The collective storage of securities in a vault in order to eliminate physical movement of **Certificates** or documents of ownership when transfer of ownership occurs.

Instruction

A correctly formatted and authenticated message from a client to execute a Transaction.

International Central Securities Depository (ICSD)

A central securities **Depository** that provides **Clearance** and **settlement** of **Transactions** in global and **International Securities** and **domestic Securities** traded across borders.

Intra-CSD settlement

Settlement between two T2S participants located in the same T2S CSD (for example, a transaction between two LuxCSD participants).

IOA

See **Issue Outstanding Amount**.

IPAR

Income Pre-Advice Report. Provides clients with information about future cash and securities proceeds and capital repayments for all the securities that are held in their accounts.

IPMA

International Primary Markets Association. An organisation founded by Euromarket participants to provide a forum for the discussion of standards for **Primary Market** practices.

ISO

International Organisation for Standardisation. The international federation of standardisation bodies for various industries that seeks to set common international standards in a variety of fields.

Issuer

A company, or government body, that borrows or raises funds through the sale of securities.

Issuer Agent

A generic term describing an entity that acts on behalf, and upon request, of the Issuer. The term “Agent” includes any Principal Paying Agent, Issuing and Paying Agent, Fiscal Agent, Registrar, or any other agent appointed by the Issuer.

Issuing Agent

Under the terms and conditions of an issue or facility, the agent responsible for arranging the issue of notes or **Certificates**.

L

Lead Manager

The financial institution that is primarily responsible for the overall coordination, distribution and documentation of a **Primary Market** (new) issue. The Lead Manager is primarily responsible to the borrower or **Issuer** for selecting the co-managers, determining the terms of the issue, and selecting underwriters and the members of the selling group.

Link

A contractual arrangement between LuxCSD and a CSD in a domestic market that enables clients of LuxCSD to execute Transactions in domestic securities with counterparties in the domestic market.

LBN

LuxCSD Bearer Global Note.

LDN

LuxCSD Dematerialised Note.

LMFP

Late Matching Fail Penalty.

One of the two types of cash penalties. LMFP applies due to the matching taking place after the ISD.

LNTC

Last Night Time Cycle in T2S.

LPA

LuxCSD Principal Agent. The LPA is appointed by the Issuer to provide the link between the Issuer and LuxCSD ensuring timely and accurate processing of the security.

M

Mark-Down (MD)

A decrease in the **Issue Outstanding Amount (IOA)** of a security.

Mark-Up (MU)

The initial amount and any subsequent increase in the **Issue Outstanding Amount (IOA)** of a security.

Matching, Matching for settlement

The process that compares the mandatory **settlement** and optional trade details given by the two **counterparties** to a trade in their **instructions**. **Presettlement Matching** makes this comparison for information purposes. **Matching for settlement** takes place as part of the **settlement** process on the basis of actual **Transactions** presented for **settlement**.

Message Type (MT)

Refers to Swift Message Types that can be used by **clients** to send **instructions** and messages, and to receive reports. For example, “MT54x” refers to Message Types 540, 541, 542 and 543.

MTF

Multi Lateral Trading Facility.

N

NCB

National Central Bank

NTS

Night Time Settlement in T2S.

New Issue

Security offered for the first time.

Nominal Amount

Face value.

P

Paying Agent

The financial institution(s) responsible for the task of making due payments of principal and interest to the holders of an issue of a security against presentation of the security or its **Coupons**. The **Principal Paying Agent** is responsible for collecting the money due from the **Issuer** and for coordinating the distribution of payments, through the sub-Paying Agents, to the holders of the issue, on demand.

PBD

Penalties Business Day. Used for the penalties-specific monthly reporting, appeals, and payment processing. This is any day of the year except for 1 January, 25 December, Saturdays and Sundays.

Pending

In LuxCSD, Pending **Transactions** are those that have reached the **Processing Date** for **settlement** but which are withheld from the **settlement** processing awaiting confirmation of the occurrence of an event. Examples are **Transactions** in **New Issue** securities where confirmation of actual **Closing** is awaited; and **Transactions** released for purchase of securities in a domestic market where confirmation of **settlement** is awaited from the LuxCSD **Depository** or **Clearing** system in the domestic market.

Pool Factor

Factor to be applied to the **Nominal Amount** of a security, reflecting partial **Redemptions**, to obtain the **Issue Outstanding Amount**.

Primary Market

The market in which securities are first issued, subscribed and distributed.

Priority Code

Transactions that have a Priority Code are given prior consideration in the allocation of available **Provision** for the **settlement** of **Transactions** over an account. The sequence in which **Transactions** over an account are considered for **settlement** is also affected by the **settlement Sequence Option** selected by the **client** for the account. A Priority Code can be input by the **client** when the **instruction** is first submitted to LuxCSD or, subsequently, while the **instruction** is in **Suspense**.

The **client** cannot input a Priority Code on cash **instructions**. Cash available on the account will always be used first to **Provision** securities purchases before a withdrawal, provided that the security **instruction** fulfils the conditions to settle.

Provision

The availability of cash or securities on an account to execute a **Transaction**.

R

Receipt Against Payment / Receipt Versus Payment

The irrevocable payment of cash upon presentation of securities (the receipt side) to settle a **Transaction**.

Receipt Free of Payment

A **Transaction** for the irrevocable receipt of securities into a LuxCSD account without an associated payment of funds from the LuxCSD account.

Record Date

The date, established by an **Issuer** of a security, used by CBL to determine, at the end of that day (that is, after End of day processing) the holders that are entitled to a corporate action.

Redemption

In accordance with the terms and conditions of an issue, partial or full return of the debt **Certificates** of an **Issuer**, for cancellation of the **Certificates** against payment to the holder.

Requested settlement Date

The date given by the client for settlement of the transaction. Within the meaning of CSDR, the Requested Settlement Date is referred to as intended settlement date.

Restricted Period

The Lock-Up Period. This is the time during which sales restrictions apply to **Euro-instruments** (normally the first 40 days of a euro-issue). It corresponds to the period that the issue is in global form only, before exchange into definitive **Certificates**.

RTS

In the context of settlement services, acronym standing for Real-Time Settlement.

RTS 2017/390

Commission Delegated Regulation (EU) 2017/392 of 11 November 2016 supplementing Regulation (EU) No 909/2014 of the European Parliament and of the Council with regard to regulatory technical standards on certain prudential requirements for central securities depositories and designated credit institutions offering banking-type ancillary services.

RTS 2017/392

Commission Delegated Regulation (EU) 2017/390 of 11 November 2016 supplementing Regulation (EU) No 909/2014 of the European Parliament and of the Council with regard to regulatory technical standards on authorisation, supervisory and operational requirements for central securities depositories.

S

SDR

Commission Delegated Regulation (EU) 2018/1229 of 25 May 2018 supplementing Regulation (EU) No 909/2014 of the European Parliament and of the Council with regard to regulatory technical standards on settlement discipline. Full text available [here](#).

SE

Stock Exchange

Secondary Market

The market for tradeable securities that is made by market makers after the completion of **Primary Market (New Issue)** distribution by **Lead Managers** to the initial **Allottees** and until final **Redemption**.

Security Code

Code used to identify a specific security. For example: **common code, ISIN**.

SEFP

Settlement Fail Penalty.

One of the two types of cash penalty. SEFP applies due to the non-settlement of a matched transaction on or after its ISD.

Settlement

The completion of a **Transaction**, wherein securities and corresponding funds are delivered and credited to the appropriate accounts.

Settlement Agent

A legal entity whose account is used to settle on behalf of another legal entity.

Settlement Date (Actual)

The date on which the settlement actually takes place.

Settlement Sequence Option

According to their own business needs, **clients** can select one of four **Settlement Sequence Options** on an account. The Settlement Sequence Option chosen determines the criteria by which **Transactions** for **settlement** over the account are sequenced for use of the available **Provision** unless a **Priority Code** is given. Settlement Sequence Options cannot be changed on a day-to-day basis.

Short selling

Short Selling is the selling, the transfer or the delivery, whether free or against payment, of an asset that the **client** does not own in its account.

Short selling of income or corporate action proceeds

Short selling of income or corporate action proceeds is the selling of securities with entitlement to the income or corporate action proceeds covered by a receipt of the same securities without entitlement to the income or corporate action proceeds. It occurs when a client settles a delivery of securities cum-dividend/coupon from an account with a receipt of securities ex-dividend/coupon into the same account. This scenario arises when the trade date for the delivery is prior to the ex-dividend/coupon date, whereas the trade date for the receipt is after the ex-dividend/coupon date.

SSR

Regulation (EU) No 236/2012 of the European Parliament and of the Council of 14 March 2012 on short selling and certain aspects of credit default swaps.

Full text available [here](#).

The list of exempted shares under SSR is available [here](#).

Swift

Formal abbreviation of the Society for Worldwide Interbank Financial Telecommunications. Also abbreviated as Swift.

T

T2 RTGS

T2 RTGS is a real time gross settlement (RTGS) system which is complemented by a central liquidity management (CLM) system that optimises liquidity management across all Target services.

Trade Date

The date on which a trade is executed or made.

Trade Price

The price or rate agreed between **counterparties** to a trade.

Transaction

An economic flow that reflects the creation, transformation, exchange, transfer or extinction of economic value and involves changes in ownership of goods and/or financial assets, the provision of services, or the provision of labour and capital.

T2S

TARGET2-Securities, the Eurosystem's single technical platform enabling central securities depositories (CSDs) and national central banks to provide core, borderless and neutral securities settlement services in central bank money in Europe. T2S went live on 22 June 2015.

U

Unpublished Account

A **client** account excluded from any list published by LuxCSD, usually an additional account opened at the request of **clients** to facilitate their own internal account management.

V

Value date

The date applied by LuxCSD for the purposes of interest calculation to funds debited from or credited to an account.

This page has intentionally been left blank.

Contact
reachus@luxcsd.com

Published by
LuxCSD

Registered address
LuxCSD S.A.
42, avenue J.F. Kennedy
L-1855 Luxembourg

Postal address
LuxCSD S.A.
L-2967 Luxembourg

Document number: LU0021
